

CD RECEIVER

# KDC-4047UA/UG/UGY/UM KDC-414UA/414UM KDC-MP245U KDC-U3046/U346/U4046 SERVICE MANUAL

# KENWOOD

Kenwood Corporation

© 2009-11 PRINTED IN JAPAN  
B53-0767-10 (N) 341

KDC-4047UA/UG : Panel assy (A64-5002-12)

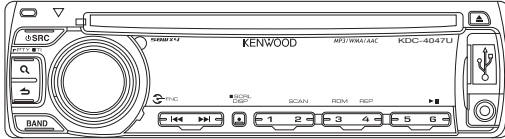

KDC-4047UGY : Panel assy (A64-5004-12)

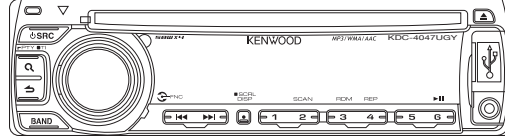

KDC-4047UM : Panel assy (A64-5131-12)

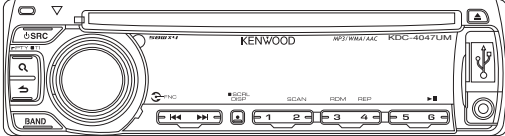

KDC-414UA : Panel assy (A64-5003-12)



KDC-414UM : Panel assy (A64-5132-12)

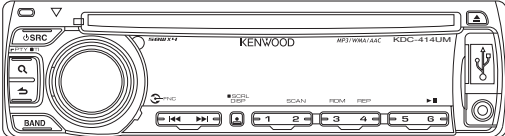

KDC-MP245U : Panel assy (A64-5001-12)

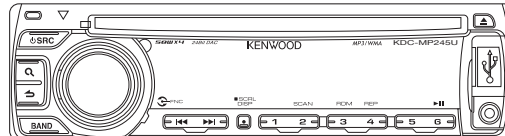

KDC-U3046 : Panel assy (A64-5008-12)

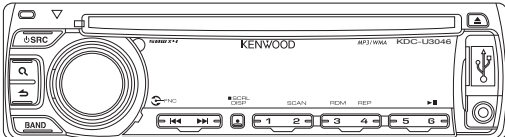

KDC-U346 : Panel assy (A64-5009-12)



KDC-U4046 : Panel assy (A64-5016-12)

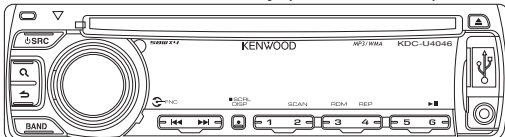

## TDF SPARE-PANEL

MAIN UNIT NAME	TDF PARTS No.	TDF NAME
KDC-4047UA	Y33-3242-73	TDF-4047UA
KDC-4047UG	Y33-3242-74	TDF-4047UG
KDC-4047UGY	Y33-3242-76	TDF-4047UGY
KDC-4047UM	Y33-3250-23	TDF-4047UM
KDC-414UA	Y33-3242-75	TDF-414UA
KDC-414UM	Y33-3250-24	TDF-414UM
KDC-MP245U	Y33-3240-11	TDF-MP02DU
KDC-U3046	Y33-3250-21	TDF-U3046
KDC-U346	Y33-3250-22	TDF-U346
KDC-U4046	Y33-3253-02	TDF-U4046

Escutcheon  
(B07-3270-01)

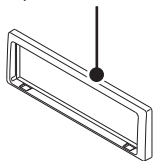

\* Carrying case  
(W01-1710-05)

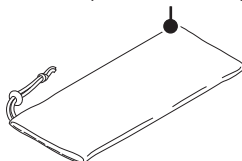

Mounting hardware assy  
(J22-0789-03)

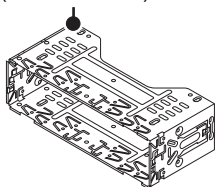

\* DC cord  
(E30-xxxx-xx)

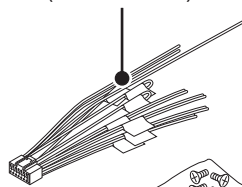

\* Screw (4x16)  
(N84-4016-48)



\* Screw set  
(N99-1757-15)



\* DC cord  
(E30-xxxx-xx)

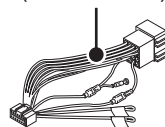

\* Remote controller assy (RC-405)  
(A70-2104-05)

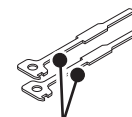

Lever  
(D10-7106-04) x2

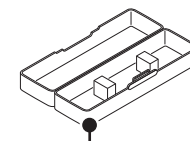

\* Plastic cabinet assy  
(A02-2755-23)

\* Depends on the model. Refer to the parts list.

This product uses Lead Free solder.

This product complies with the **RoHS** directive for the European market.





## COMPONENTS DESCRIPTION

### ● SWITCH UNIT (X16-675x-xx)

Ref. No.	Application / Function	Operation / Condition / Compatibility
IC1	VFD Driver	
IC2	Remote Control Sensor	

### ● ELECTRIC UNIT (X34-660x-xx)

Ref. No.	Application / Function	Operation / Condition / Compatibility
IC1	System $\mu$ -COM	Controls FM/AM tuner, CD mechanism, panel, volume and tone.
IC2	E-VOL	Controls the source, volume, tone.
IC4	Power Supply IC	Outputs 5Vx2, 8.3V, 10.2V, P-CON, P-ANT.
IC6	Power IC	Amplifies the front L/R and the rear L/R to 50W maximum.
IC7	RDS IC	RDS decoder.
IC8	Reset IC	Lo when detection voltage goes below 3.6V.
IC10	E2PROM	Tuner setting memory. (Not used)
IC51	USB+5V	Power supply for D+5.1V. (to USB and panel)
IC52	Hi-side SW	Detects USB over current.
IC53	D+3.3V AVR IC	Power supply for D+3.3V.
IC251	Level Shift (3.3V $\rightarrow$ 5V)	Logic IC.
IC252	Level Shift (5V $\rightarrow$ 3.3V)	Logic IC.
IC501	Tuner IC (ATomIC)	Tuner IC.
IC900	Bolero $\mu$ -COM	USB/CD mechanism control.
IC951	Bolero E2PROM	(Not used)
Q2,3	Servo+B AVR	When Q3's base goes Hi, AVR outputs 7.5V.
Q11,12	CONT SW for Servo+B	ON when the base goes Hi.
Q13	CONT SW for IC4	ON when the base goes Hi.
Q14	CONT SW for IC4	ON when the base goes Lo.
Q53	FREQ CONT SW for IC51	When the base goes Lo, switching frequency becomes 1.3MHz. When the base goes Hi, switching frequency becomes 1.8MHz.
Q101	ACC DET	ON when the base goes Hi during ACC is applied.
Q102	Surge DET	When the base goes Hi, surge voltage is detected.
Q103	BU DET	ON when the base goes Hi during BU is applied.
Q104,105	Mute CONT	ON when the base goes Hi.
Q301	Panel 5V SW	ON when the base goes Lo.
Q705,706	Pre-out Mute SW	When a base goes Hi, pre-out is muted.
Q707	Mute Driver for Pre-out	ON when the base goes Lo.
Q902,903	3.3V AVR for IC900	When base of Q902 is Hi, 3.3V is ON.
Q905	CD "LOE LIM SW" Buffer	When base of Q905 is Hi, loadingnd end completes.

## COMPONENTS DESCRIPTION

### ● CD PLAYER UNIT (X32-6250-00)

Ref. No.	Application / Function	Operation / Condition / Compatibility
IC3	4ch BTL Driver	Driver for focusing & tracking coil, driver for sled & spindle motor, and operation for disc loading & ejection.
IC4	Servo DSP with built-in Audio DAC	With built-in MP3/WMA/ACC decoder and 1M-bit-SRAM.
IC5	BU1.5V/D3.3V REG.	Power supply for BU1.5V. Power supply for digital/analogue/audio 3.3V.
Q1	APC (Auto Power Control)	Drives LD (Laser Diode).
Q14	D1.5V Output	Switches ON/OFF at one end of BU1.5V line which is separated into 2 directions. Uses output voltage as D1.5V.
D2	Laser Diode Protection	Prevents reverse bias which is applied to laser. Laser destruction prevention.
D3,4	Static Electricity Countermeasure	Prevents malfunction by static electricity.

## MICROCOMPUTER'S TERMINAL DESCRIPTION

### ● SYSTEM $\mu$ -COM : IC1 on X34- (ELECTRIC UNIT)

Pin No.	Pin Name	I/O	Application	Truth Value Table	Processing / Operation / Description
1~5	NC	-	Not used		Output L fixed
6	REMO	I	Remote control signal input		Detects pulse width
7	NC	-	Not used		Output L fixed
8	BYTE	I	Memory extension bus width setting		Connects to VSS
9	CNVSS	-			Connects to VSS
10	XCIN	-	32.768kHz		
11	XCOU	-	32.768kHz		
12	RESET	-			L: Reset
13	XOUT	-	16.0MHz		
14	VSS	-			
15	XIN	-	16.0MHz		
16	VCC1	-			
17	NC	-	Not used		Output L fixed
18	PANEL DET	I	Panel communication detection		H: No panel, L: Panel detached
19~24	NC	-	Not used		Output L fixed
25	PON FL	O	Key illumination power supply control		ON: H, OFF: L
26	PON PANEL	I/O	Panel 5V control		ON: L, 11 minutes after momentary power-down or panel detached or ACC OFF: Hi-Z
27	NC	-	Not used		Output L fixed
28	BEEP	O	Beep output		2kHz / 1kHz
29	TUN SCL	I/O	Tuner I2C clock output		
30	TUN SDA	I/O	Tuner I2C data input/output		

## MICROCOMPUTER'S TERMINAL DESCRIPTION

Pin No.	Pin Name	I/O	Application	Truth Value Table	Processing / Operation / Description
31	VFD SYS DATA	O	VFD data output		VFD data output. VFD_BLK (Pin34) is made Hi and the communication begins after 500ms.
32	VFD PAN DATA	I	VFD data input		
33	VFD CLK	O	VFD clock output		125kHz
34	VFD BLK	O	VFD driver reset output		H: Reset cancelled, L: Reset, 11 minutes after momentary power-down or panel detached or ACC OFF: L
35	S SYS DATA	O	Bolero serial output		
36	S SOC DATA	I	Bolero serial input		
37	S SOC CLK	I	Bolero serial clock input		
38	CD LOS SW	I	CD loading detection		
39	CD LOE LIM SW	I	CD detection (Chucking SW)		H: Loading completed, L: No disc
40	CD LOEJ	I/O	CD motor control	①	Refer to the truth value table
41	ROMCOR DET	I	E2PROM writing request		H: Writing
41	EPM	I	Flash ROM EPM input		L: Rewritable (Only when flash ROM is used). Connects to VSS.
42	CD MOTOR	I/O	CD motor control	①	Refer to the truth value table
43	NC	-	Not used		Output L fixed
44	CD DISC12 SW	I	12cm disc detection		
45	NC	-	Not used		Output L fixed
46	VFD CE	O	VFD control request		H: Possible to transfer VFD data
47	AUD SDA	I/O	E-VOL data input/output		
48	AUD SCL	I/O	E-VOL clock output		
49	ROTARY CCW	I	VOL encoder input		Detects pulse width
50	ROTARY CW	I	VOL encoder input		Detects pulse width
51	RDS DATA	I/O	RDS decoder data input		
52	RDS QUAL	I	RDS decoder qualification input		
53	SOC MUTE	I	CD mute request		H: Normal, L: Mute request
54	S SOC REQ	I	Communication request from SOC to system $\mu$ -com		
55	SOC RST	O	SOC reset		H: Normal, L: Reset
56	SOC S STOP	O	SOC stop		H: Normal, L: SOC stopped
57	S SYS REQ	O	Communication request from system $\mu$ -com to system $\mu$ -com to SOC		
58-61	NC	-	Not used		Output L fixed
62	VCC2	-			
63	NC	-	Not used		Output L fixed
64	VSS	-			
65-73	NC	-	Not used		Output L fixed
74	RDS CLK	I/O	RDS decoder clock input		
75	NC	-	Not used		Output L fixed
76	PWIC STBY	O	Power IC standby control		POWER ON: H, POWER OFF: L

## MICROCOMPUTER'S TERMINAL DESCRIPTION

Pin No.	Pin Name	I/O	Application	Truth Value Table	Processing / Operation / Description
77	PWIC MUTE	O	Power IC mute		STANDBY source or momentary power-down: L, TEL mute: L
78	MUTE	I/O	Mute		L: Mute OFF, Hi-Z: Mute ON
79	$\overline{\text{BU DET}}$	I	Momentary power-down detection		BU found: L, No BU or momentary power-down: H (Operates within 4ms after momentary power-down is detected)
80	$\overline{\text{ACC DET}}$	I	ACC power supply detection		ACC found: L, No ACC: H
81	TYPE1	I	Destination SW		Refer to the truth value table
82	TYPE2	I	Destination SW		Refer to the truth value table
83	NC	-	Not used		Output L fixed
84	PWIC DC ERR	I	Detection of power IC short-circuited +B/GND		
85	LINE MUTE	I	Line mute selection		TEL mute: Below 1V, NAVI mute: Over 2.5V
86	TUN SMETER	I	S-meter input		
87	PON SWREG	O	SW-REG ON/OFF		H: ON, L: OFF
88	AUD DC ERR	I	DC offset selection		If DC offset is detected 20 times in 100ms with condition below 1.0V, it will be judged as DC offset is detected.
89	FSEL	O	SW-REG frequency SW		H: 1.3MHz, L: 1.8MHz
90,91	NC	-	Not used		Output L fixed
92	PS2 1	O	Power supply IC control	②	Refer to the truth value table
93	PS1 1	O	Power supply IC control	②	Refer to the truth value table
94	PS1 2	O	Power supply IC control	②	Refer to the truth value table
95	PS1 3	O	Power supply IC control	②	Refer to the truth value table
96	AVSS	-			
97	NC	-	Not used		Output L fixed
98	VREF	-			
99	AVCC	-			
100	NC	-	Not used		Output L fixed

### • Truth value table

#### ① CD motor control

	CD MOTOR (Pin 42)	CD LOEJ (Pin 40)
Stop	L	L
Load	H	L
Eject	H	H
Brake	H	Hi-z

#### ② Power supply IC (IC4) control

##### SEL1 (Pin 10)

PS1-2	PS1-3	PS2-1	ILLUMI	P-CON	P-ANT
L	L	L	OFF	OFF	OFF
L	L	H	ON	OFF	OFF
H	L	H	ON	ON	OFF
H	H	H	ON	ON	ON

##### SEL2 (Pin 11)

PS1-1	PS2-2	AUDIO/SW5	AM
L	L	OFF	OFF
H	L	ON	OFF
H	H	ON	ON

## MICROCOMPUTER'S TERMINAL DESCRIPTION

### ● Bolero $\mu$ -COM : IC900 on X34- (ELECTRIC UNIT)

Pin No.	Pin Name	I/O	Application	Processing / Operation / Description
1	MRST	-	Reset	L: Reset, H: Normal
2	MSTOP	I	Stop signal from system $\mu$ -com	H: Normal, L: SOC stop
3	REQ S	I	Request signal from system $\mu$ -com	L: Request
4	NC	-	Not used	
5	BSIF ST REQ	I	BSIF	
6	VCC	-	Power supply	
7	XT1	-	Low frequency oscillator	Sub clock 32.768kHz
8	XT2	-	Low frequency oscillator	Sub clock 32.768kHz
9	PWE	-	External power supply output	L: Stop
10	DVSS	-	GND	
11	DVCC1B	-	For SRAM with built-in power supply	
12	RVOUT1	-	Built-in REG1.5V output	
13,14	RVIN	-	Built-in REG power supply input	
15	RVOUT2	-	Built-in REG1.5V output	
16	DVCC1A	-	For logic with built-in power supply	
17	DVSS	-	GND	
18~22	NC	-	Not used	Output L fixed
23	CD CCE	O	CD mechanism chip enable	Command I/F
24	CD RST	O	CD mechanism reset	H: Normal, L: Reset
25	NC	-	Not used	Output L fixed
26	DVSS	-	GND	
27	DVCC3A	-	For I/O around power supply	
28	CD REQ	I	Communication request from mechanism DSP	H: Data request
29	CD SRAM STBY	O	Decoder SRAM standby control	L: SRAM standby
30	CD DRIVE MUTE	O	CD motor driver mute output	
31	CD PON	O	CD mechanism power supply control output	H: Power supply ON, Hi-z: Power supply OFF
32~43	NC	-	Not used	Output L fixed
44	DVSS	-	GND	
45	DVCC3A	-	For I/O around power supply	
46~54	NC	-	Not used	Output L fixed
55	NC (IPOD CHECK)	-	For iPod authentication IC mounting confirmation	Outputs Hi when iPod communication is detected
56~61	NC	-	Not used	Output L fixed
62	DVSS	-	GND	
63	DVCC3A	-	For I/O around power supply	
64	NC	-	Not used	Output L fixed
65	ZDET IN	I	ZDET (0-bit mute request)	L: Normal, H: Mute request
66	CD MUTE	O	Mute request to system $\mu$ -com	L: Mute request, H: Normal
67	REQ M	O	Request signal to system $\mu$ -com	L: Request
68	IPOD RST	O	Reset	
69	BOOT	I	For flash ROM writing	

## MICROCOMPUTER'S TERMINAL DESCRIPTION

Pin No.	Pin Name	I/O	Application	Processing / Operation / Description
70	NC	-	Not used	Output L fixed
71	BSIF LRCK	-	BSIF	
72	AM1	-	Fixes operation mode to "1"	
73	X2	-	High frequency oscillator	Main clock 9.00MHz
74	DVSS	-	GND	
75	X1	-	High frequency oscillator	Main clock 9.00MHz
76	DVCC3A	-	For I/O around power supply	
77	USB OC	I	USB over-current detection	L: Detected, H: Normal
78	USB PON	O	USB-PON output	
79	USB D+	-	USB data connection	
80	USB D-	-	USB data connection	
81	AM0	-	Fixes operation mode to "1"	
82	CD LOE LIM SW	I	CD detection (Chucking SW)	L: Loading completed, H: No disc
83	DVSS	-	GND	
84	DATA M	O	Serial I/F to system $\mu$ -com (Transmission)	
85	DATA S	I	Serial I/F from system $\mu$ -com (Reception)	
86	CLK	O	Serial I/F to system $\mu$ -com (Clock output)	f=1MHz
87	CD SO	O	Serial I/F (Transmission)	Command I/F
88	CD SI	I	Serial I/F (Reception)	Command I/F
89	CD CLK	O	Serial I/F (Clock output)	f: Below 1MHz
90	IPOD SDA	I/O	I2C-iPod authentication data input/output	
91	IPOD SCLK	I/O	I2C-iPod authentication clock output	f=80kHz
92	BSIF BCK	-	BSIF	
93	BSIF DATA	-	BSIF	
94	BSIF GATE	O	BSIF	
95	DVCC3A	-	For I/O around power supply	
96	ROM COR DET	I	ROM correction writing detection	H: writing
97-99	NC	-	Not used	
100	DVSS	-	GND	



# TEST MODE

## ■ Example

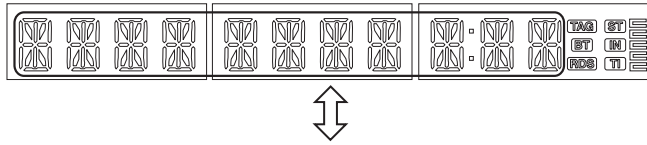

Key	Description of display	Description

A symbol “■” in the key column indicates that the key should be pressed and held.

Key	Description of display	Description
5		Disc Eject times display (Max. 65535 times).
■ 5	Disc Eject times display	While Disc Eject times is displayed, press and hold for 2 seconds or longer to clear Disc Eject times.

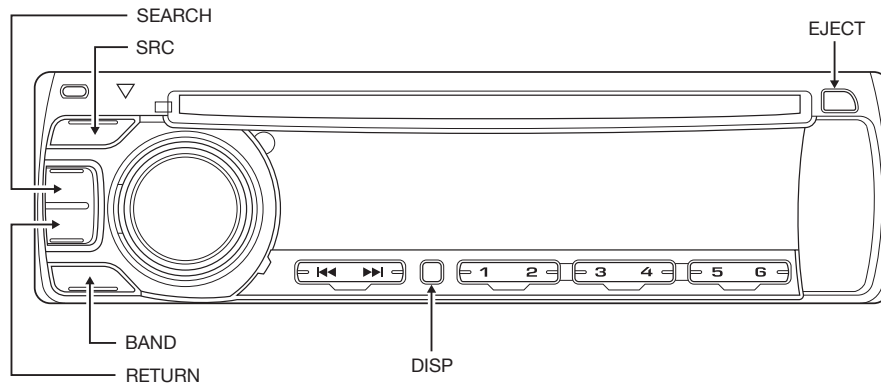

## ● How to enter the Test mode

Procedure	Note
Press and hold the [1] key and [3] key and reset.	

All lamps blinks when it is detected that the sub-clock resonator is disconnected.

When having started up in the Test mode, change the LINE MUTE inhibition time from 10 seconds to 1 second.

In the Test mode, do not write the detection information in the Data Flash ROM even if a DC Offset Error is detected.

Do not operate the DEMO mode in the Test mode, CD Mechanism Error Log Information Clear Mode, or DC Offset Error Detection Information Clear Mode.

Also, when the source is STANDBY in the above mode, do not display DEMO ON/OFF switching items in the FUNCTION.

In the Test mode, the forced disc ejection operation is prohibited.

## ● How to clear the Test mode

Procedure	Note
Reset, Momentary power down, ACC OFF, Power OFF, Panel detached.	



# TEST MODE

Key	Description of display	Description	
BAND	ROM correction version display	<div style="display: flex; justify-content: space-around;"> <span>S 0 0 0 1</span> <span>M 0 0 0 1</span> </div> <System μ-com>    <Mechanism μ-com>	The number is the ROM correction version number.
		<div style="display: flex; justify-content: space-around;"> <span>S - - - -</span> <span>M - - - -</span> </div> <System μ-com>    <Mechanism μ-com>	When not written in yet.
		<div style="display: flex; justify-content: space-around;"> <span>S * * * *</span> <span>M * * * *</span> </div> <System μ-com>    <Mechanism μ-com>	When data not matched *Due to the difference in versions.
▶▶	Audio data initialization	A U D I O   I N I T	Audio setting value is re-set to the Test mode default value.
◀◀	Forced Power OFF information display	P O F F   - - -	No forced Power OFF
		P O F F   P N L	Forced power OFF by communication error between system μ-com and panel.
■◀◀			While the forced power OFF data is displayed, press and hold for 2 seconds to clear the data.
DISP	CD information display	Transition to the CD information display mode (sub-mode)	*Refer to “CD information display mode” for the details of display and operation procedure. Press [DISP] key briefly.
■DISP	CD information display mode ON/OFF	Clear all of the CD information	Press and hold this key for 2 seconds in the CD information display mode to clear all of the CD information. Press and hold the [DISP] key.
■SEARCH	Preout switching	S W P R E   R E A R S W P R E   S U B - W	Pressing and holding this key for 1 second switches the preout. (Except KDC-4047UGY)
RETURN	FL display Short circuit check	<div style="display: flex; justify-content: space-around;"> <span> </span><span> </span><span> </span><span> </span><span> </span><span> </span><span> </span><span> </span><span> </span><span> </span><span> </span><span> </span> </div>	Turn off all the terminals → At every 125ms, turn on the maximum odd number terminal and the maximum even number terminal of the grid alternatively → Turn on only the odd number terminals → Turn on only the even number terminals →

# TEST MODE

• CD information display mode (sub-mode)

Key	Key	Description of display	Description
BAND (forward rotation)	I◀◀ / ▶▶I	CD mechanism error log display	M E C H A □ E R 1 : X X Mechanism error log 1 (Latest) XX: Error number. The "--" is displayed in case there is no error.
			M E C H A □ E R 2 : X X Mechanism error log 2 (Latest) XX: Error number. The "--" is displayed in case there is no error.
			M E C H A □ E R 3 : X X Mechanism error log 3 (Latest) XX: Error number. The "--" is displayed in case there is no error.
	I◀◀ / ▶▶I	CD load error information display	L O A D □ □ E R 1 : X X Load error switch 1 XX: The number of errors. The "--" is displayed in case there is no error.
			L O A D □ □ E R 2 : X X Load error switch 2 XX: The number of errors. The "--" is displayed in case there is no error.
	I◀◀ / ▶▶I	CD ejection error information display	E J E C T □ E R 1 : X X Ejection error switch 1 XX: The number of errors. The "--" is displayed in case there is no error.
			E J E C T □ E R 2 : X X Ejection error switch 2 XX: The number of errors. The "--" is displayed in case there is no error.
			E J E C T □ E R 3 : X X Ejection error switch 3 XX: The number of errors. The "--" is displayed in case there is no error.
			E J E C T □ E R 4 : X X Ejection error switch 4 XX: The number of errors. The "--" is displayed in case there is no error.
	I◀◀ / ▶▶I	CD time code error count information display (Missing counts)	C N T □ L O S E □ □ □ CD time code error count information (Missing counts) mode is display.
			C D D A □ □ □ □ : X X Number of CD-DA error counts XX: The number of errors. The "--" is displayed in case there is no error.
			C D R O M □ □ □ □ : X X CD-ROM (Compression file) number of count errors XX: The number of errors. The "--" is displayed in case there is no error.
I◀◀ / ▶▶I	CD time code error count information display (Count is not updated.)	C N T □ S T A Y □ □ □ CD time code error count information (Count is not updated) mode display.	
		C D D A □ □ □ □ : X X Number of CD-DA error counts XX: The number of errors. The "--" is displayed in case there is no error.	
		C D R O M □ □ □ □ : X X CD-ROM (Compression file) number of count errors XX: The number of errors. The "--" is displayed in case there is no error.	

# TEST MODE

## • Design version information display mode (sub-mode)

Key	Description of display	Description
BAND (forward rotation)	Destination terminal condition display T Y P E 2 1 □ □ □ : 1 1	TYPE indicates μ-com destination, and indicates condition of the destination terminal in real-time.
	Development ID condition display 0 9 2 8 W E 2 - 3 . 0 0	Development code - Version (system μ-com)

## ■ Test mode in Tuner source

If the following display is shown when the source is TUNER, it indicates an error.

Status	Description of display	Description
TUNER IC communication error	T U N □ C O N □ N G □	This display indicates the status in which the communication with TUNER IC is not possible.
The adjustment is not yet made.	* E R R * A □ 9 8 . 3 A	This display indicates the status in which the TUNER adjustment has never been made (Adjustment value: 0X00 or 0XFF) However the following TUNER test mode functions are valid (Note that the display, “*ERR*” remains as it is.)

## • TUNER band switching operation

Key	Description of display	Description
BAND	BAND switching operation F M 1 - 4 A □ 9 8 . 3 A	Every time when the [BAND] key is pressed, the BAND is switched as listed in the next table for each TYPE.

TYPE	BAND1	BAND2	BAND3	BAND4	BAND5	BAND6	Description
K1	①FM1	FM2	FM3	②AM	-	-	① → ②
E2/E3/E4/ E5/M4/M5	①FM1	FM2	FM3	②MW/LW	-	-	① → ②
M2/M3/C2	①FM1	FM2	FM3	②MW	③SW1	④SW2	① → ② → ③ → ④

\* TYPE: See the parts list.

## • Switch in injection setting / packs setting

In the TUNER FM source, every time the [5] key is pressed and held for 1 second the injection setting switches in the following sequence of order: AUTO → H → L → AUTO.

In the TUNER FM source, every time the [6] key is pressed and held for 1 second the packs setting switches in the following sequence of order: AUTO → 1 → 2 → . . . 7 → AUTO.

In both settings, the default condition is AUTO, which is displayed as shown in the next table.

Key	Description of display	Description
■5	Injection setting switching	F M 1 - 4 A □ 9 8 . 1 A A: Injection setting AUTO
		F M 1 - 4 A □ 9 8 . 1 H H: Injection setting H
		F M 1 - 4 A □ 9 8 . 1 L L: Injection setting L
■6	Packs setting switching	F M 1 - 4 A □ 9 8 . 1 A A: Packs setting AUTO
		F M 1 - 4 7 □ 9 8 . 1 A X: Packs setting 1~7

# TEST MODE

## • TUNER setting adjustment mode

This mode is to adjust TUNER setting.

Key	Note
■DISP	Press this key to change the mode to the TUNER setting adjustment (Press and hold the key for 1 second). When the source is FM, frequency is switched to 98.3MHz at the start of the adjustment mode. Press and hold the [DISP] key.

Procedures in the TUNER setting adjustment mode are as follows:

## • Adjustment mode switching (AUTO/MANUAL)

Key	Description of display	Description
■BAND (forward rotation)	Level Offset adjustment (Auto) [A] [ ] [S] [-] [X] [X] [ ] [L] [-] [X] [X]	Press and hold the [BAND] key for 1 second to select the TUNER adjustment method (A: AUTO / M: MANUAL). S-XX → Present S meter value (HeX) L-XX → Level offset value (HeX)
	Level Offset adjustment (Manual) [M] [ ] [S] [-] [X] [X] [ ] [L] [-] [X] [X]	*When the level offset value is not yet adjusted (0XFF or 0X00), "--" is displayed.

## • Procedure in the AUTO adjustment mode

Key	Description of display	Description
ROTARY	In automatic adjustment [A] [ ] [S] [-] [X] [X] [ ] [L] [-] [X] [X]	Press this key briefly to start the automatic adjustment.
	Completion of automatic adjustment Save the adjustment value. [A] [D] [J] [ ] [O] [K] [ ] [ ] [ ] [X] [X] (Level offset value)	After the completion of the automatic adjustment, save the level offset value in the Data Flash ROM and display the resultant level offset value (HeX).
	Failure of the automatic adjustment Cannot save the adjustment value. Save the failed value (0XFF).	Display shown when the automatic adjustment failed (Write 0XFF in the Data Flash ROM. → Given the 0XFF saved in the ROM, the adjustment starts with "--" when the automatic adjustment mode is re-started.)
RETURN	Mode clear [F] [M] [1] [-] [4] [A] [ ] [9] [7] [.] [9] [A]	This is to clear the FST adjustment mode (in normal operation) (The display returns to the normal display and the test mode is retained.) Frequency is switched to 97.9MHz.
	Mode clear [*] [E] [R] [R] [*] [A] [ ] [9] [7] [.] [9] [A]	This is to clear the FST adjustment mode (when failed in the automatic adjustment) (The display returns to the normal display and the test mode is retained.) Frequency is switched to 97.9MHz.

# TEST MODE

## • Procedure in MANUAL adjustment mode

Key	Description of display		Description
[◀◀/▶▶] [▶▶/▶▶]	Level Offset adjustment (Manual)	M □ S - X X □ L - X X	Press [◀◀/▶▶] key for 500ms or longer to continuously increase / decrease the adjustment value.
ROTARY	Completion of the adjustment value saving	A D J □ O K □ □ □ : X X (Level offset value)	Display when the adjustment value has been saved in the Data Flash ROM The saved level offset value (HeX) is displayed.
	Failed to save the adjustment value	A D J □ N G □ □ □ □ □	Display when the adjustment value has not been saved in the Data Flash ROM
RETURN	Mode clear	F M 1 - 4 A □ 9 7 . 9 A	This is to clear the FST adjustment mode (in normal operation) (The display returns to the normal display and the test mode is retained.) Frequency is switched to 97.9MHz.
		* E R R * A □ 9 7 . 9 A	This is to clear the FST adjustment mode (when failed in the automatic adjustment) (The display returns to the normal display and the test mode is retained.) Frequency is switched to 97.9MHz.

After the TUNER setting adjustment, the entire test modes can be cleared with the reset button.

If you do not save the adjustment value in the Data Flash ROM after the adjustment, the value is not saved in the ROM. When the level offset value is read out and found to be 0X00 or 0XFF, it is decided that the adjustment is not yet made. The adjustment starts with the default value (0X3E) when the adjustment is re-started from the status in which it is not yet made.

Setting is not yet adjusted: L □ □ □



[◀◀/▶▶] key operation

Start the adjustment: L □ 3 E



[◀◀/▶▶] key operation

Increase / Decrease the adjustment value: L □ X X

## • S-meter voltage pass and fail evaluation mode

This mode is to display the S-meter present voltage (HeX) and to check and evaluate if the voltage is within the criteria or not (OK or NG). Check and evaluate the voltage only after the completion of the TUNER setting adjustment. (When the setting is not yet adjusted, "--" is displayed.)

When receiving AM, do not select this mode.

In this mode, the BAND switching and SEEK operations such as operation of [BAND], [◀◀/▶▶], and [PRESET] keys shall be prohibited.

Key	Description of display		Description
RETURN	S-meter voltage pass and fail evaluation display ON/OFF	S - M T R □ □ X X : O K	[S-meter value] XX: Present S-meter value (HeX)
		S - M T R □ □ X X : N G	[S-meter value evaluation result] OK: S-meter voltage is within the range of the criteria (0XA3-0XAD) NG: S-meter voltage is outside of the range of the criteria (Outside of the above range)
		S □ □ M T R □ □ X X : N G	--: TUNER setting is not yet adjusted.

# TEST MODE

## • RDS automatic measurement

This automatic measurement is implemented in place of the visual inspection of the PS display that had been carried out in the production line.

Status	Description of display	Description
PS data reception	R D S <input type="checkbox"/> T E S T <input type="checkbox"/> <input type="checkbox"/> <input type="checkbox"/>	The P-CON is forcibly turned off when the display in the left cell is shown. P-CON is recovered by turning the power OFF and ON (Power OFF/ON).

## ■ Test mode in CD source

Display mode default	P-Time
----------------------	--------

## • Procedure in CD-DA media (KTD-02A)

Key		Description of display	Operation
▶▶	Track up procedure		Every time pressed, jumps to the track shown below. No.9 → No.15 → No.10 → No.22 → No.12 → No.13 → No.14 → No.9 (recursive) But in case the disc has 8 tracks or less, playback starts with track No.1 (at both of CD-DA and compressed file disc).
◀◀	Track down procedure		Goes down by 1 track from the currently played track.
1	Jump procedure		Jump to No.28. (0.7mm scratch for MUSIC line vibration test)
2	Jump procedure		Jump to No.14. (Blurring surface disc: TCD-731RA Tr14)
3 (forward rotation)	Information display Mechanism model name Mechanism version	9 B 2 0 <input type="checkbox"/> <input type="checkbox"/> <input type="checkbox"/> <input type="checkbox"/> <input type="checkbox"/> <input type="checkbox"/> <input type="checkbox"/> <input type="checkbox"/>	Mechanism model name and mechanism version display
	Information display Mechanism Servo version	S E R V <input type="checkbox"/> <input type="checkbox"/> <input type="checkbox"/> <input type="checkbox"/> <input type="checkbox"/> <input type="checkbox"/> <input type="checkbox"/> <input type="checkbox"/>	Mechanism servo table version display
	Information display Mechanism Boot program version	B O O T <input type="checkbox"/> <input type="checkbox"/> <input type="checkbox"/> <input type="checkbox"/> <input type="checkbox"/> <input type="checkbox"/> <input type="checkbox"/> <input type="checkbox"/>	Mechanism boot program version display
4	Jump procedure		Jump to No.15. Set the volume value to "26". (For 20Hz 0dB DC protection error operation FCT checking)
5	Jump procedure	*Switch the track jump from No.9 to No.22 or from No.22 to No.9 (No.9 ↔ No.22)	When the track No.22 is being played back, this key makes the track jump to No.9.
			When the track No.9 is being played back, this key makes the track jump to No.22.
6	PLAY/PAUSE procedure		This key is to switch from PLAY to PAUSE and vice versa (PLAY/PAUSE). (Normal operation)



# TEST MODE

• Procedure in compressed media

Key	Description of display	Description
-	File format display (MP3) <input type="checkbox"/> M <input type="checkbox"/> P <input type="checkbox"/> 3 <input type="checkbox"/> <input type="checkbox"/> <input type="checkbox"/> <input type="checkbox"/> <input type="checkbox"/> <input type="checkbox"/> <input type="checkbox"/> <input type="checkbox"/> <input type="checkbox"/> <input type="checkbox"/> <input type="checkbox"/> <input type="checkbox"/> <input type="checkbox"/>	The file format is displayed just before the file playback.
-	File format display (WMA) <input type="checkbox"/> W <input type="checkbox"/> M <input type="checkbox"/> A <input type="checkbox"/> <input type="checkbox"/> <input type="checkbox"/> <input type="checkbox"/> <input type="checkbox"/> <input type="checkbox"/> <input type="checkbox"/> <input type="checkbox"/> <input type="checkbox"/> <input type="checkbox"/> <input type="checkbox"/> <input type="checkbox"/>	
-	File format display (AAC) <input type="checkbox"/> A <input type="checkbox"/> A <input type="checkbox"/> C <input type="checkbox"/> <input type="checkbox"/> <input type="checkbox"/> <input type="checkbox"/> <input type="checkbox"/> <input type="checkbox"/> <input type="checkbox"/> <input type="checkbox"/> <input type="checkbox"/> <input type="checkbox"/> <input type="checkbox"/> <input type="checkbox"/>	

■ Backup current measurement

Procedure	Note
Power on during ACC OFF (Back Up ON)	MUTE terminal is turned OFF after 2 seconds, not after 15 seconds. (During this time, the CD mechanism does not function.)

# TEST MODE

## ■ Clearing DC offset error detection information (Clear the Data Flash ROM)

Procedure	Note
While pressing and holding [3] key and [6] key, reset-start.	To enter DC offset error display mode.

The transition to this mode shall be possible even if the DC offset error has been detected.

This mode is cancelled by resetting. (The last screen will not be retained.)

Procedure	Description of display	Description
While pressing and holding [3] key and [6] key, reset-start.	D C □ □ E R R □ □ □ □ □	When DC offset error is detected (when either one of capacitor leak is leaking, or an improper connection or other error is detected)
	D C □ □ O K □ □ □ □ □ □	When DC offset error is not detected (when none of capacitor leak, no improper connection or other error is detected)
1	D C 1 □ E R R □ □ □ □ □	When improper connection or other DC offset errors are detected.
	D C 1 □ O K □ □ □ □ □ □	When improper connection or other DC offset errors are detected.
■ 1	D C 1 □ O K □ □ □ □ □ □	When there is any misconnection detected or when the DC offset error is displayed during the other detection period, press and hold this key for 2 seconds to clear the detection information. (Clear the Data Flash ROM)
2	D C 2 □ 4 □ □ □ □ □ □ □ □	Capacitor leak detection period display of the detected times of capacitor leaks. (0~4)
■ 2	D C 2 □ 0 □ □ □ □ □ □ □ □	Press and hold this key for 2 seconds when a capacitor leak is detected to clear the number of detection. (Clear the Data Flash ROM)

## ■ FM/AM Channel space switching (Only for models of destination “K” and “M”)

Procedure	Note
While Power OFF, pressing and holding [1] key and [5] key, and press [SRC] key to Power ON	FM200kHz/AM10kHz ↔ FM50kHz/AM9kHz (KDC-MP245U) FM50kHz/AM10kHz ↔ FM200kHz/AM10kHz (KDC-U3046/U346) FM50kHz/MW9kHz/SW5kHz ↔ FM200kHz/AM10kHz (KDC-4047UM/414UM)

## ■ Forced update

Procedure	Note
Start resetting while keeping pressing the [1] key and [SEARCH] key.	To enter the forced update mode.

After entering the mode, make the normal SRC feed with the [SRC] key, DISC insertion, and USB insertion.

The display of the SRC switches and READING is shown in the same manner as the display of the normal mode.

After the completion of READING, start the UPDATE if there is an update file.

If there is no update file, display “NO FILE”.

Procedure	Description of display	Description
	F / W □ U P □ M O D E	STANDBY condition in the forced update mode
	R E A D I N G □ □ □ □	After the SRC switches, the “READING” is displayed during reading (The display blinks)
	N O □ F I L E □ □ □ □	The “NO FILE” is displayed when there is no update file
	U P D A T I N G □ □ □ □	The UPDATE in progress is displayed after it is verified that there is an update file and while updating the file (The display blinks).
	C O M P L E T E □ □ □ □	Completion of UPDATE
	U P D A T E □ E R R □	UPDATE error

# PC BOARD (COMPONENT SIDE VIEW)

SWITCH UNIT  
X16-675x-xx (J76-0637-02)

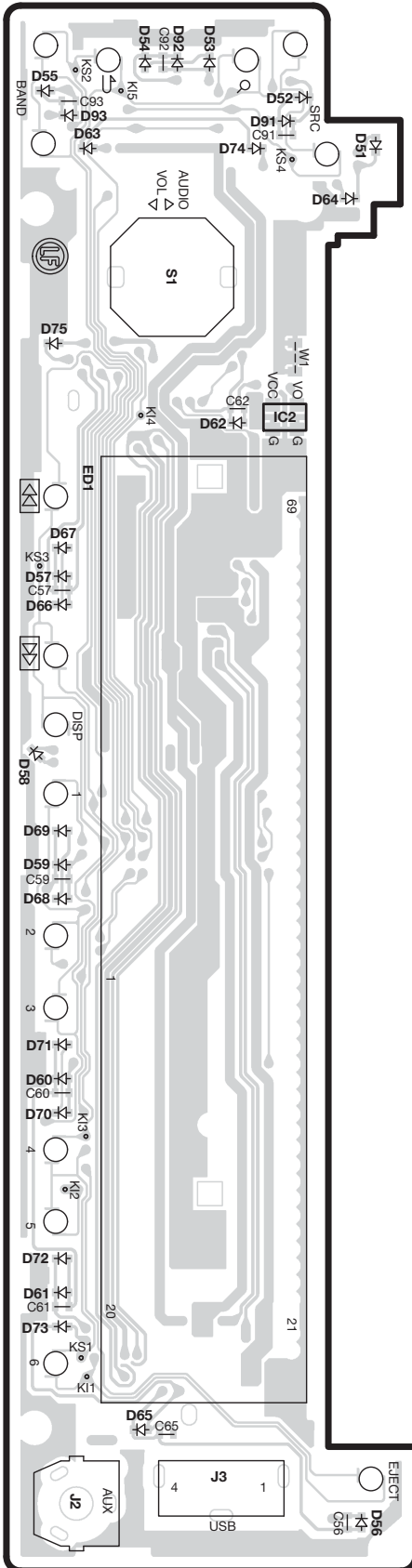

X16-675x-xx

Ref. No.	Address
IC2	3B

# (FOIL SIDE VIEW)

SWITCH UNIT  
X16-675x-xx (J76-0637-02)

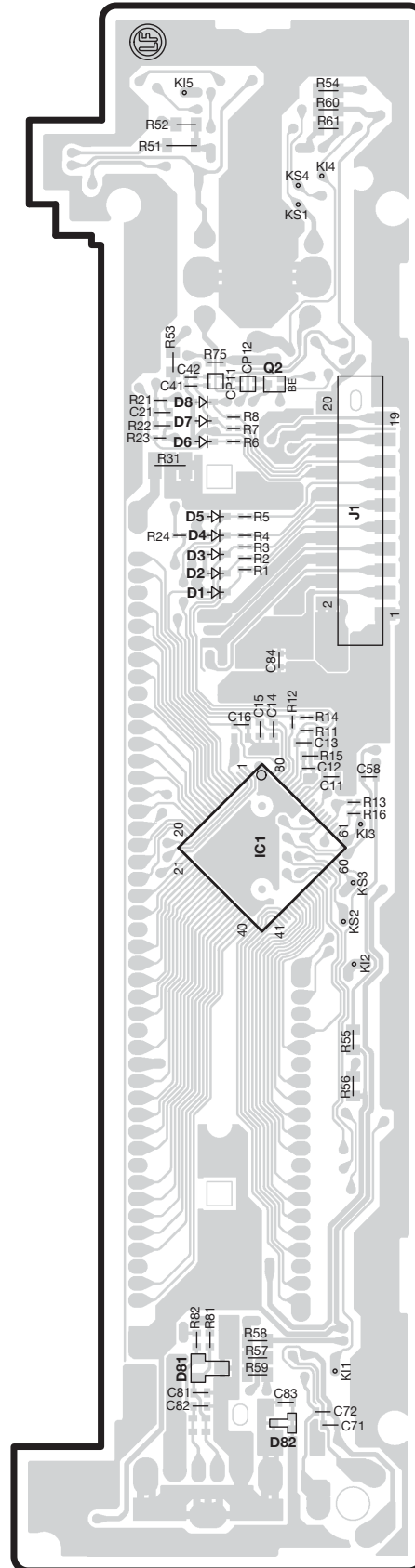

X16-675x-xx

Ref. No.	Address
IC1	4D

Refer to the schematic diagram for the values of resistors and capacitors.

# PC BOARD (COMPONENT SIDE VIEW)

## ELECTRIC UNIT X34-660x-xx (J76-0640-02)

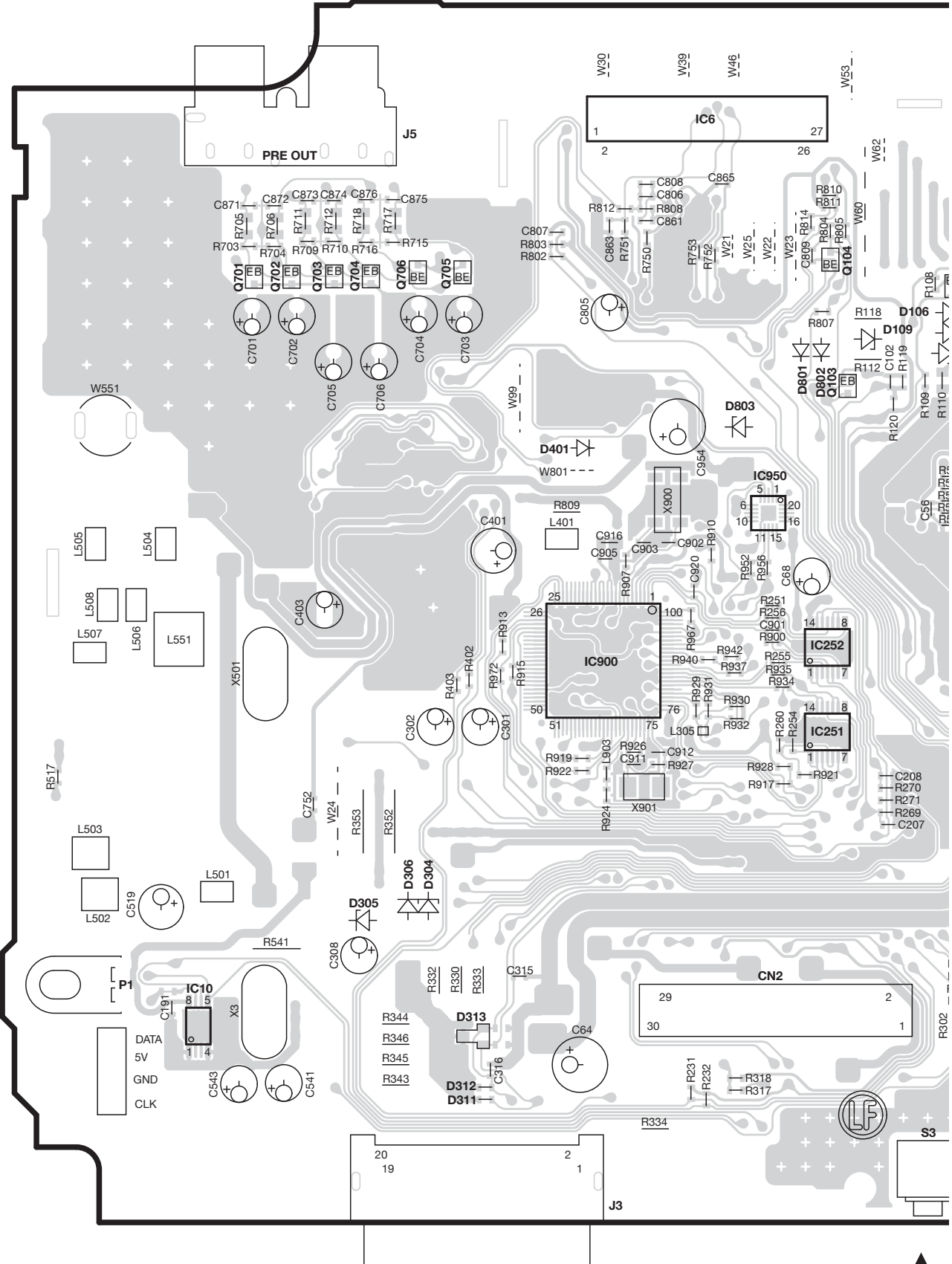

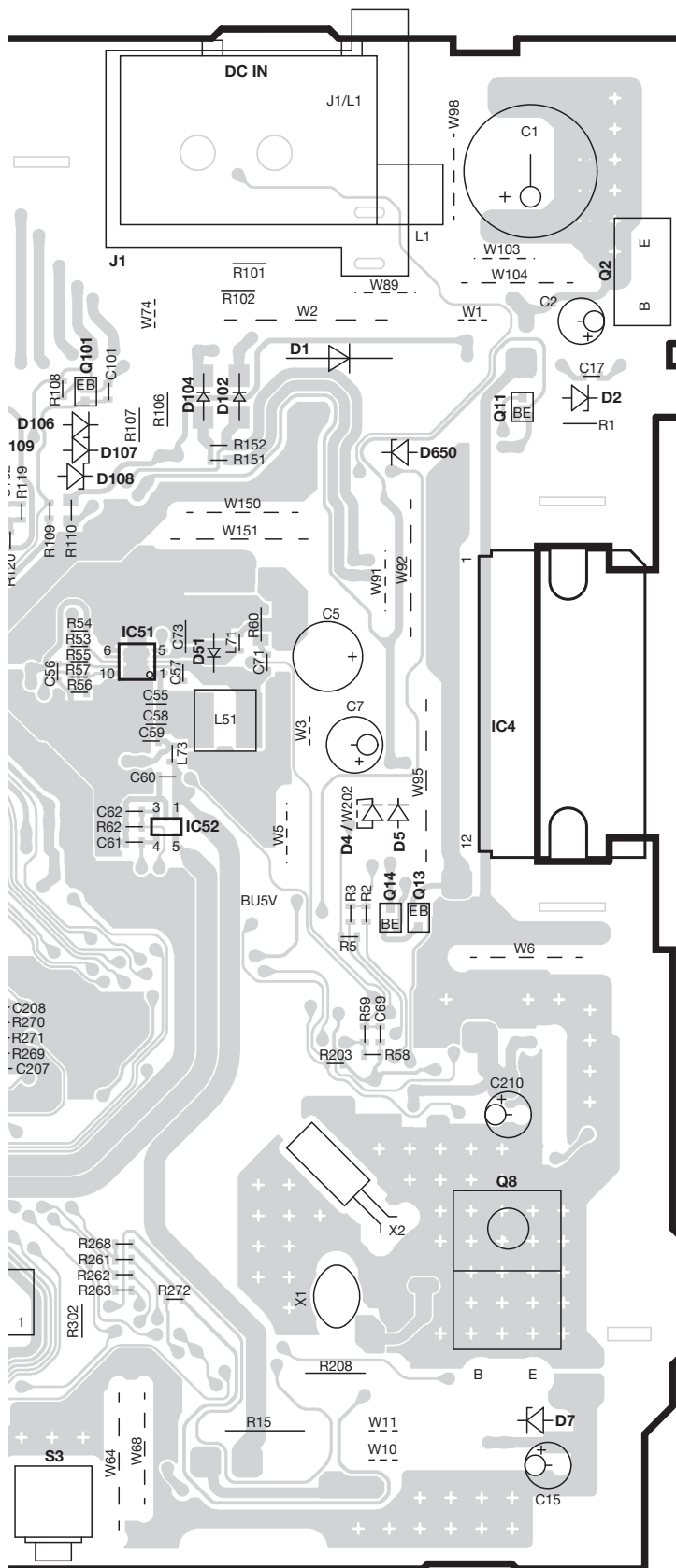

## X34-660x-xx

Ref. No.	Address
IC4	4L
IC6	2I
IC51	4K
IC52	4K
IC251	5J
IC252	4J
IC900	4I
Q2	2M
Q11	3L
Q13	5L
Q14	5L
Q101	3K
Q103	3J
Q104	3J
Q705	3H
Q706	3H

Refer to the schematic diagram for the values of resistors and capacitors.







KDC-4047UA/4047UG/4047UGY/4047UM  
KDC-414UA/414UM/MP245U/U3046/U346/U4046

# PC BOARD (COMPONENT SIDE VIEW)

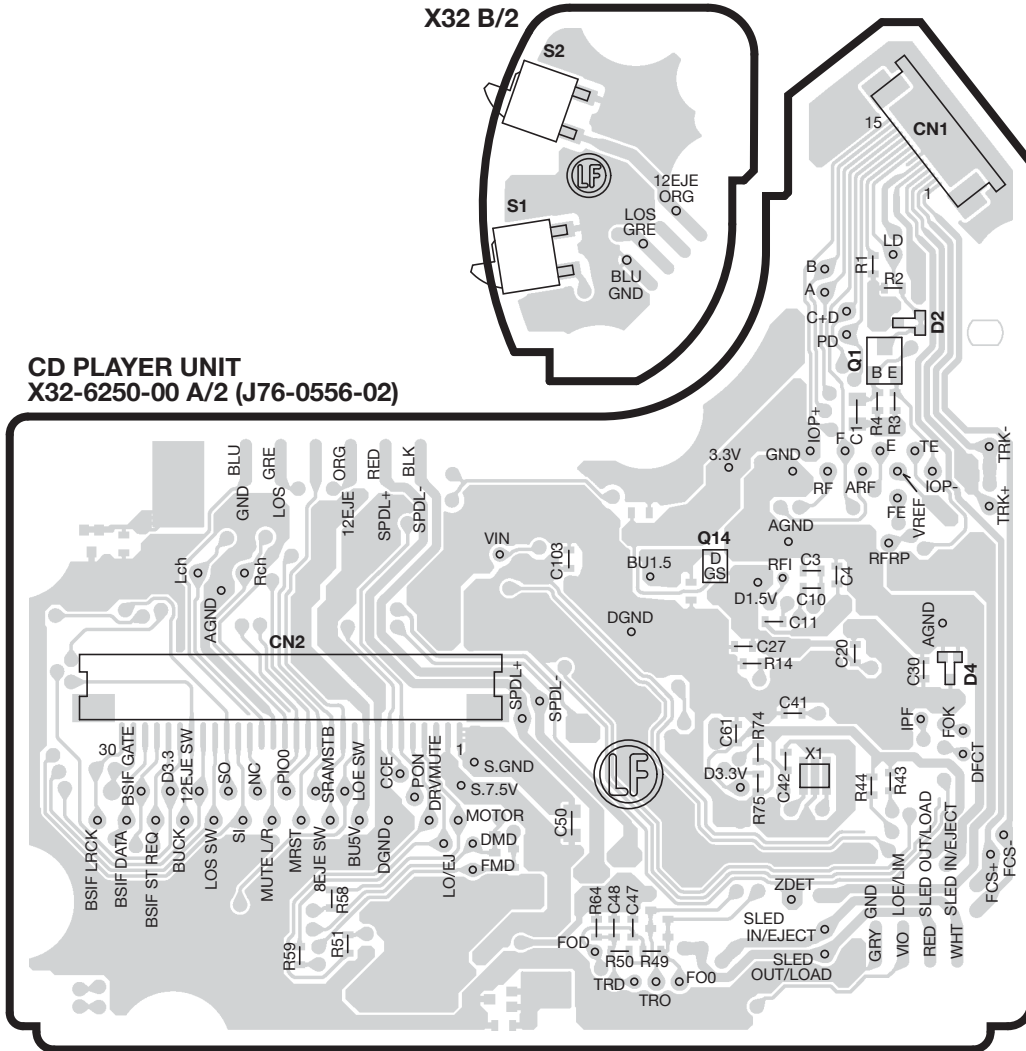

**CD PLAYER UNIT**  
**X32-6250-00 A/2 (J76-0556-02)**

**X32-6250-00**

Ref. No.	Address
Q1	2AC
Q14	3AC

Refer to the schematic diagram for the values of resistors and capacitors.



# PC BOARD (FOIL SIDE VIEW)

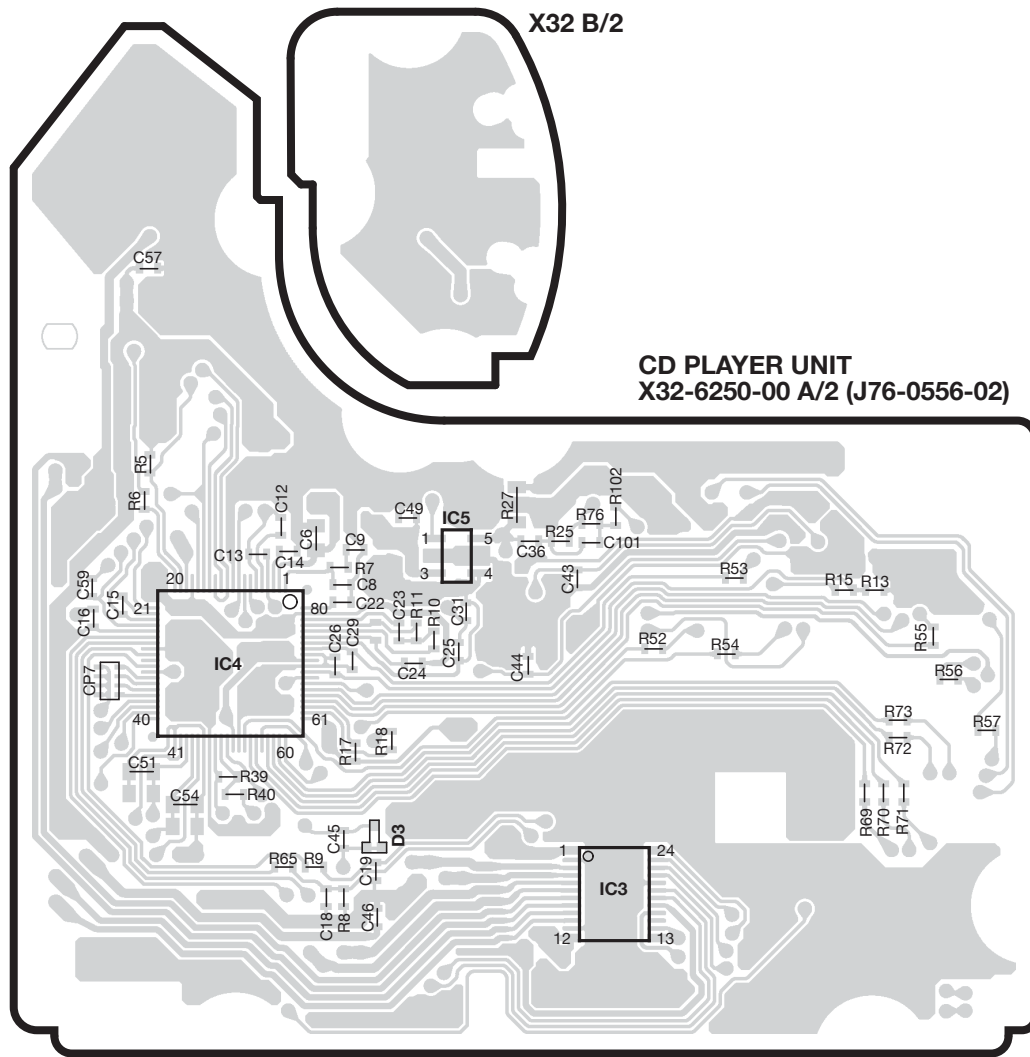

**X32-6250-00**

Ref. No.	Address
IC3	4AG
IC4	3AF
IC5	3AG

Refer to the schematic diagram for the values of resistors and capacitors.

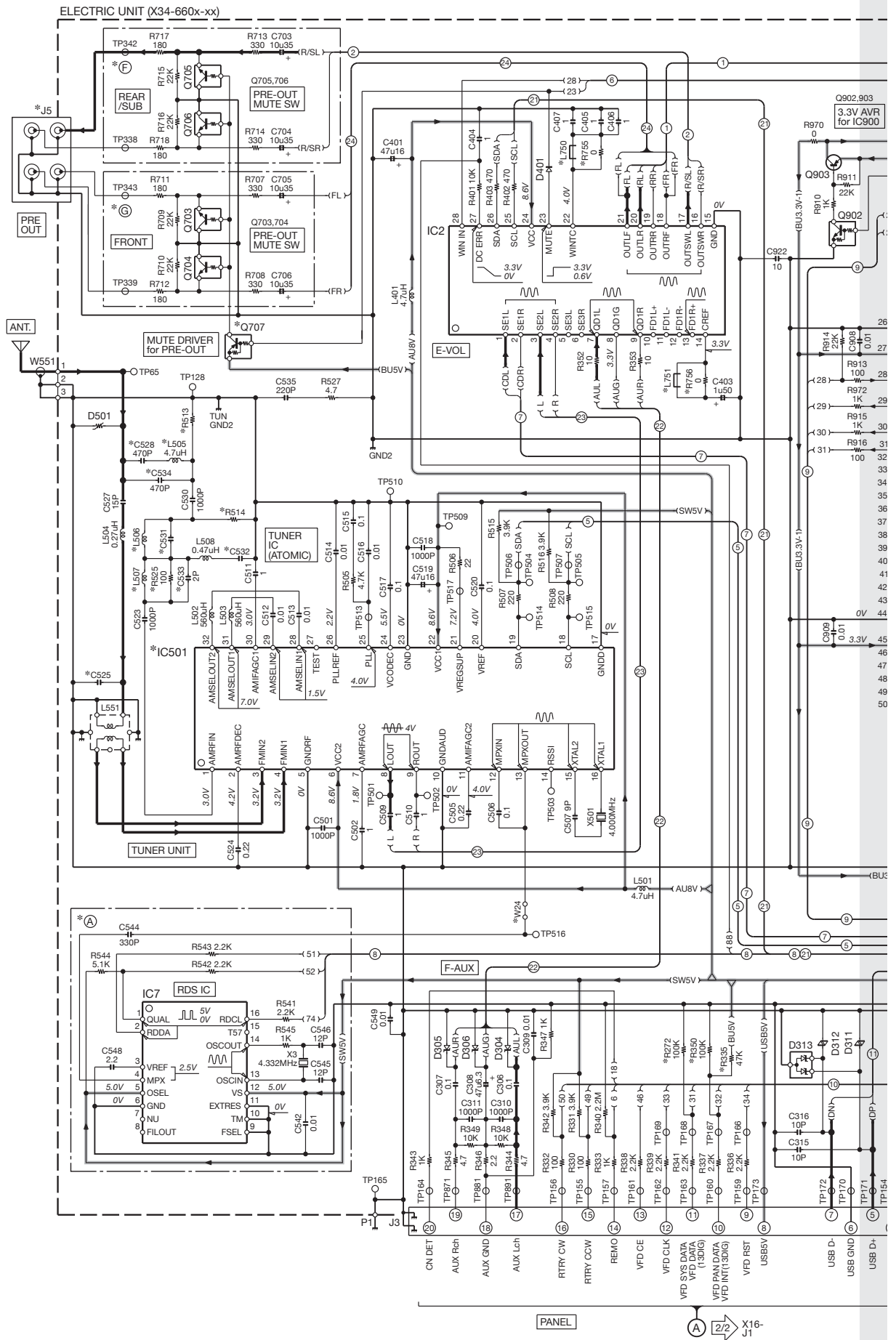

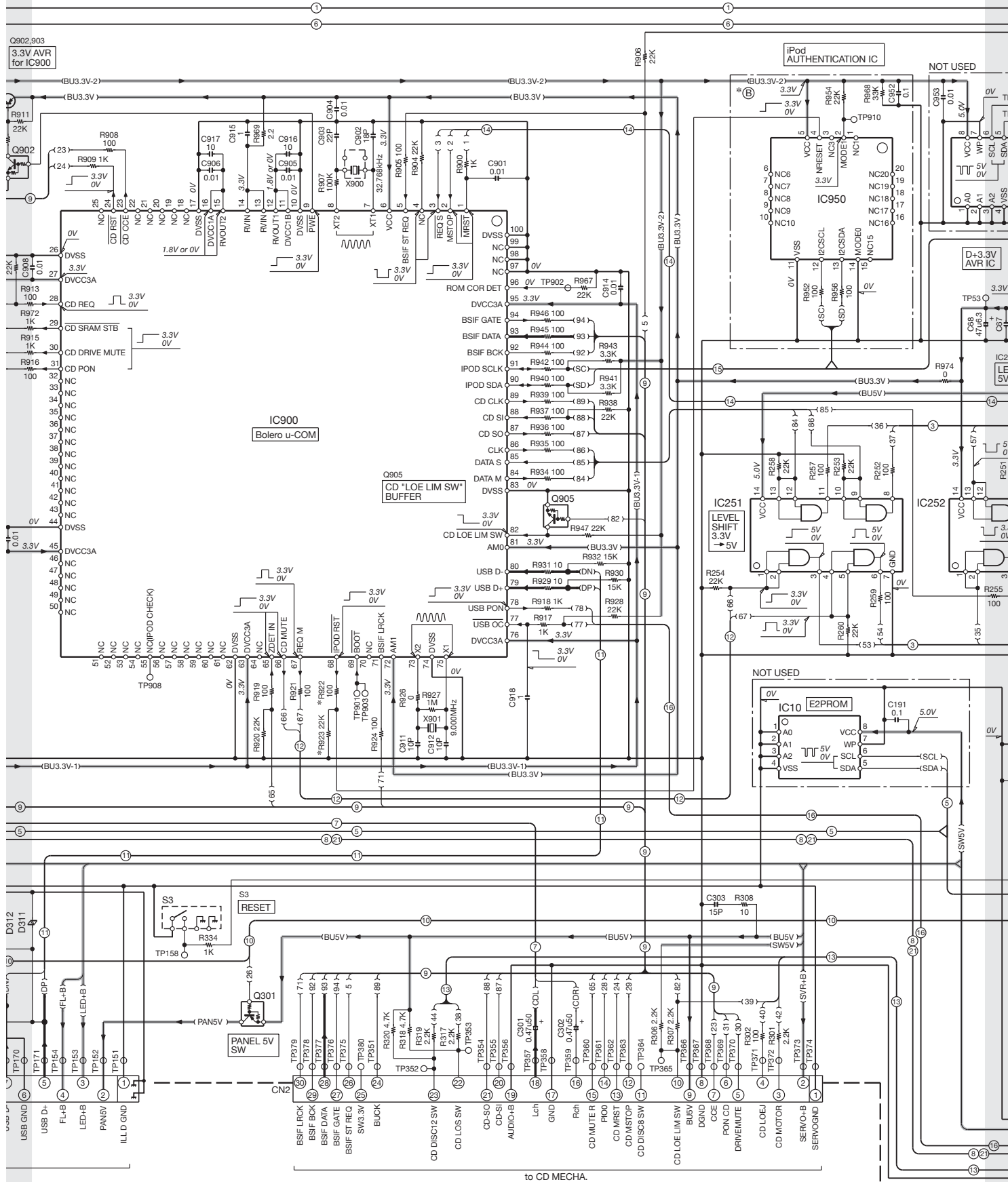

to CD MECHA.

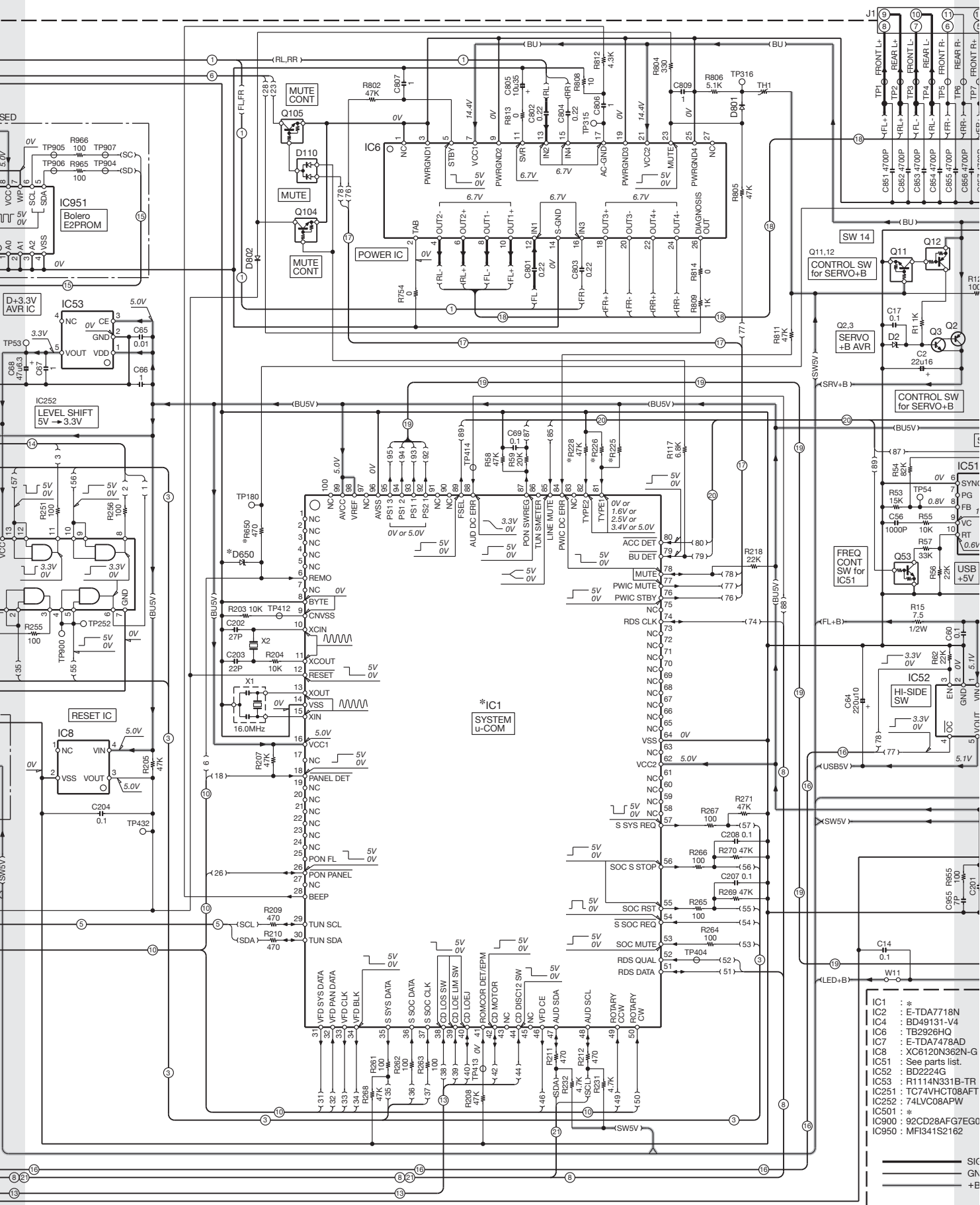

- IC1 : \*
- IC2 : E-TDA718N
- IC4 : BD49131-V4
- IC6 : TB2926HQ
- IC7 : E-TDA7478AD
- IC8 : XC6120N362N-G
- IC9 : See parts list.
- IC51 : \*
- IC52 : BD2224G
- IC53 : R1114N31B-TR
- IC251 : TC74VHCT08AFT
- IC252 : 74LVC08APW
- IC501 : \*
- IC900 : 92CD28AFG7EG0
- IC950 : MFI341S2162

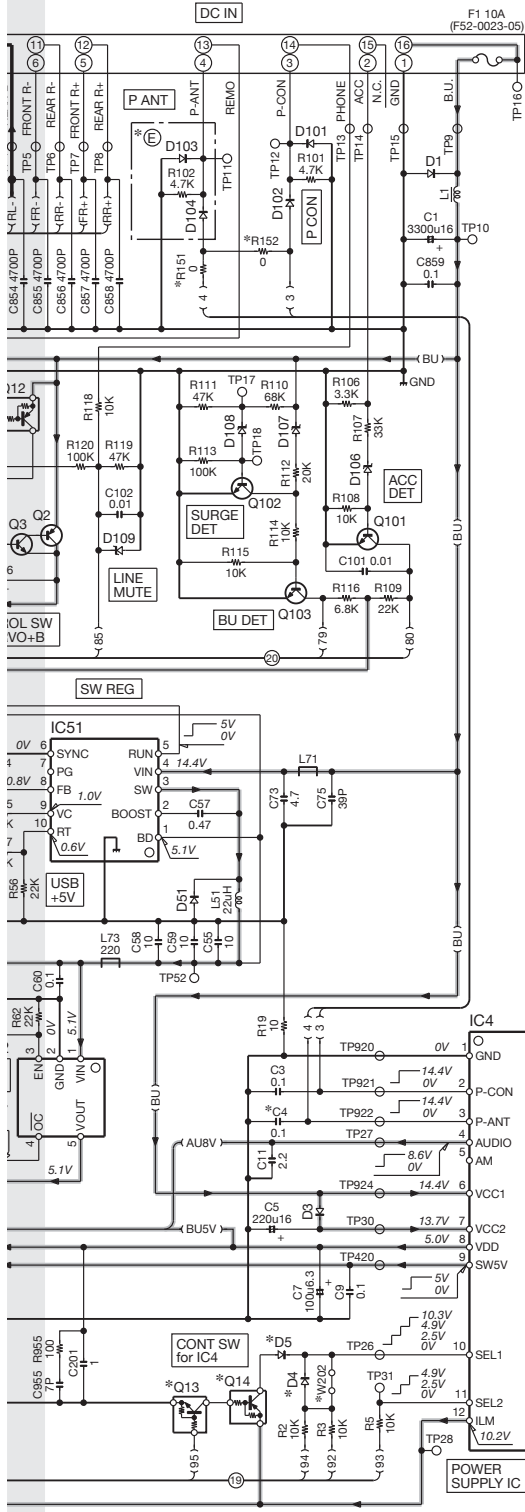

- Q2 : KTA1046-P
- Q3 : 2SC4154T1(E,F)
- Q11,13 : RT1N241M-T111
- Q12,14,707 : RT1P241M-T111
- Q53,104,105,905 : RT1N441M-T111
- Q101-103 : 2SC4081
- Q301 : RT1P144M-T111
- Q703-706 : RT1N430M-T111
- Q902 : RT1N144M-T111
- Q903 : 2SA1577
- D1 : S2V60-5009F46
- D2 : HZS9-E(A1)
- D3,101-104 : D1F60-5063
- D4,5,401,801,802 : HZS4148
- D51 : CMS14
- D106-108 : MTZJ6.8(B)
- D109 : HZS5-E(B1)
- D110 : MC2848-T111
- D304-306,650 : HZS7-E(A3)
- D311,312 : LVS10C270S030
- D313 : HZM6.8ZMWA-E
- D501 : IMSA-6802-E

ELECTRIC UNIT (K34-660x-xx)

DESTI- NATION	UNIT No.	(A)	(B)	(C)	(D)	(E)	(F)	(G)	(H)	(I)	(J)	(K)	(L)	(M)	(N)	(O)	(P)	(Q)	(R)	(S)	(T)	(U)	(V)	(W)	(X)	(Y)	(Z)
KDC-MP245U	K1	0-11	—	—	—	—	—	—	—	—	—	—	—	—	—	—	—	—	—	—	—	—	—	—	—	—	
KDC-4047UM	M4	2-72	YES	—	—	—	—	—	—	—	—	—	—	—	—	—	—	—	—	—	—	—	—	—	—	—	
KDC-414UM	M5	2-72	YES	—	—	—	—	—	—	—	—	—	—	—	—	—	—	—	—	—	—	—	—	—	—	—	
KDC-03046	M2	0-22	—	—	—	—	—	—	—	—	—	—	—	—	—	—	—	—	—	—	—	—	—	—	—	—	
KDC-03046	M3	0-22	—	—	—	—	—	—	—	—	—	—	—	—	—	—	—	—	—	—	—	—	—	—	—	—	
KDC-03046	M6	0-22	—	—	—	—	—	—	—	—	—	—	—	—	—	—	—	—	—	—	—	—	—	—	—	—	
KDC-0407UGY	E23	0-22	—	—	—	—	—	—	—	—	—	—	—	—	—	—	—	—	—	—	—	—	—	—	—	—	
KDC-414UA	E4	2-72	YES	—	—	—	—	—	—	—	—	—	—	—	—	—	—	—	—	—	—	—	—	—	—	—	
KDC-MP245U	K	0-10	—	—	—	—	—	—	—	—	—	—	—	—	—	—	—	—	—	—	—	—	—	—	—	—	
KDC-U446	M1	0-21	—	—	—	—	—	—	—	—	—	—	—	—	—	—	—	—	—	—	—	—	—	—	—	—	
KDC-U5046	C1	0-21	—	—	—	—	—	—	—	—	—	—	—	—	—	—	—	—	—	—	—	—	—	—	—	—	
KDC-4547UB/UM	E1/E	2-71	YES	YES	YES	—	—	—	—	—	—	—	—	—	—	—	—	—	—	—	—	—	—	—	—	—	

2SC4081

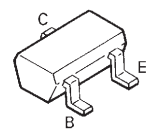

KTA1046-P

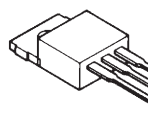

DAP202U  
DA204U

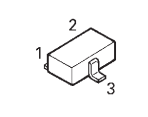

**CAUTION :** For continued safety, replace safety critical components only with manufacturer's recommended parts (refer to parts list).

⚠ Indicates safety critical components. To reduce the risk of electric shock, leakage-current or resistance measurements shall be carried out (exposed parts are acceptably insulated from the supply circuit) before the appliance is returned to the customer.

- DC voltages are as measured with a high impedance voltmeter. Values may vary slightly due to variations between individual instruments or/and units.

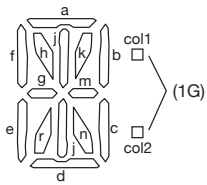

(3G-1G)



(1G)

ANODE CONNECTION

PIN NAME	3G	2G	1G
P1	1f	1f	1f
P2	2f	2f	2f
P3	3f	3f	3f
P4	4f	4f	BT
P5	1k	1k	1k
P6	2k	2k	2k
P7	3k	3k	3k
P8	4k	4k	S1
P9	1h	1h	1h
P10	2h	2h	2h
P11	3h	3h	3h
P12	4h	4h	ST
P13	1g	1g	1g
P14	2g	2g	2g
P15	3g	3g	3g
P16	4g	4g	S3
P17	1c	1c	1c
P18	2c	2c	2c
P19	3c	3c	3c
P20	4c	4c	S4
P21	1m	1m	1m
P22	2m	2m	2m
P23	3m	3m	3m
P24	4m	4m	IN
P25	1a	1a	1a
P26	2a	2a	2a
P27	3a	3a	3a
P28	4a	4a	TAG
P29	1j	1j	1j
P30	2j	2j	2j
P31	3j	3j	3j
P32	4j	4j	col1
P33	1b	1b	1b
P34	2b	2b	2b
P35	3b	3b	3b
P36	4b	4b	S2
P37	1r	1r	1r
P38	2r	2r	2r
P39	3r	3r	3r
P40	4r	4r	col2
P41	1d	1d	1d
P42	2d	2d	2d
P43	3d	3d	3d
P44	4d	4d	RDS
P45	1n	1n	1n
P46	2n	2n	2n
P47	3n	3n	3n
P48	4n	4n	TI
P49	1e	1e	1e
P50	2e	2e	2e
P51	3e	3e	3e
P52	4e	4e	S5

SWITCH UNIT (X16-675x-xx)

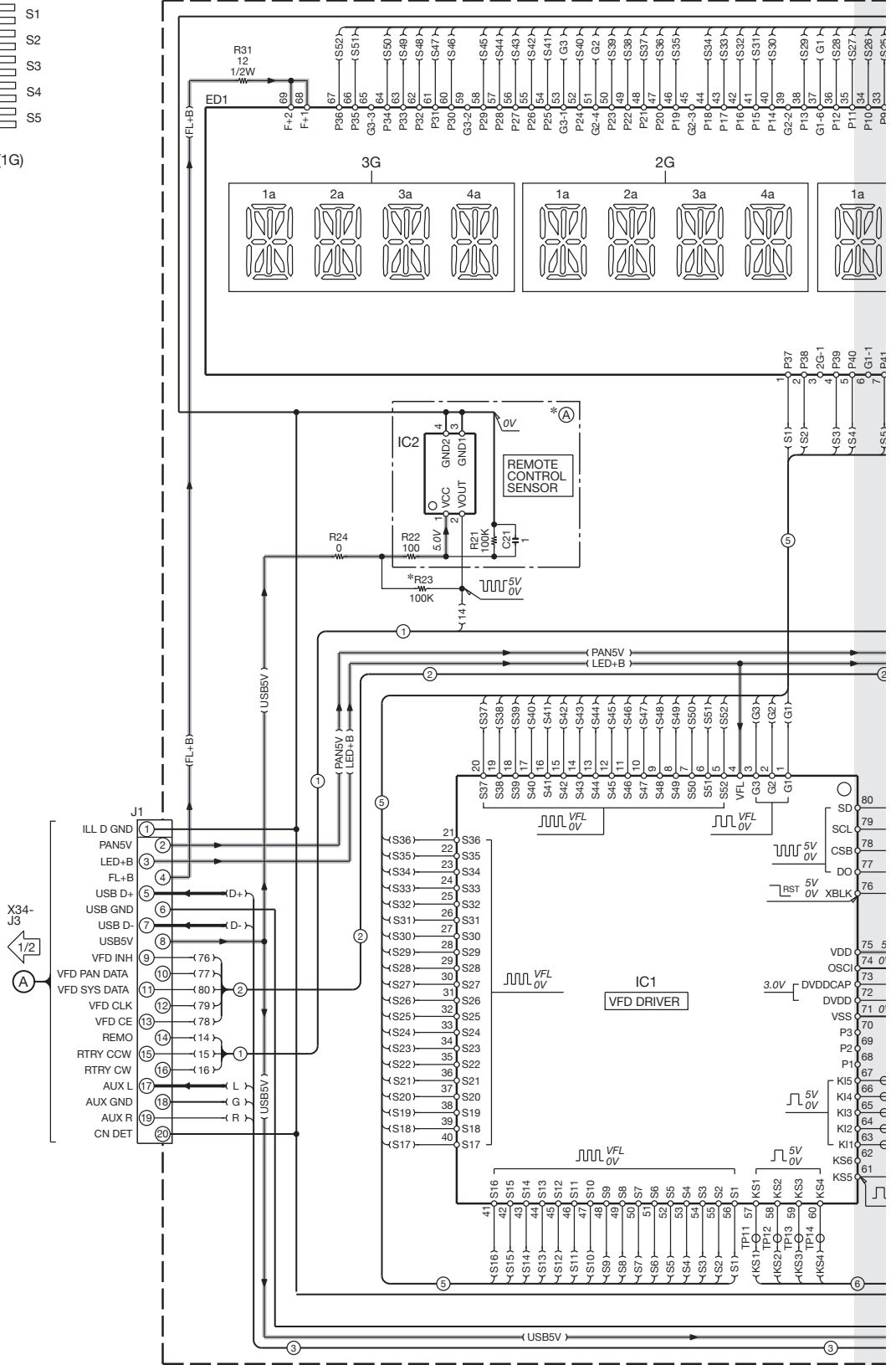





KDC-4047UA/4047UG/4047UGY/4047UM  
KDC-414UA/414UM/MP245U/U3046/U346/U4046

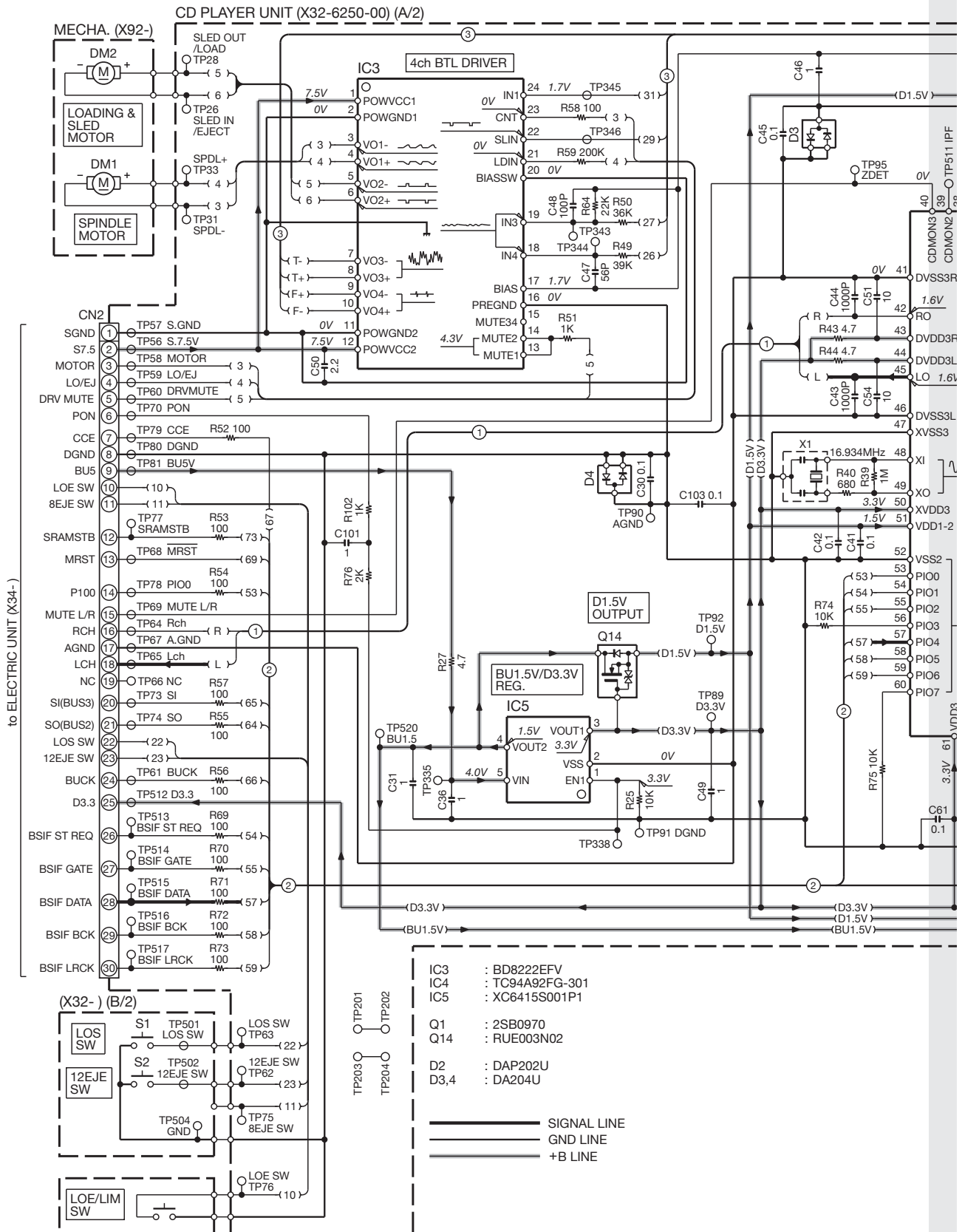







# EXPLODED VIEW (UNIT)

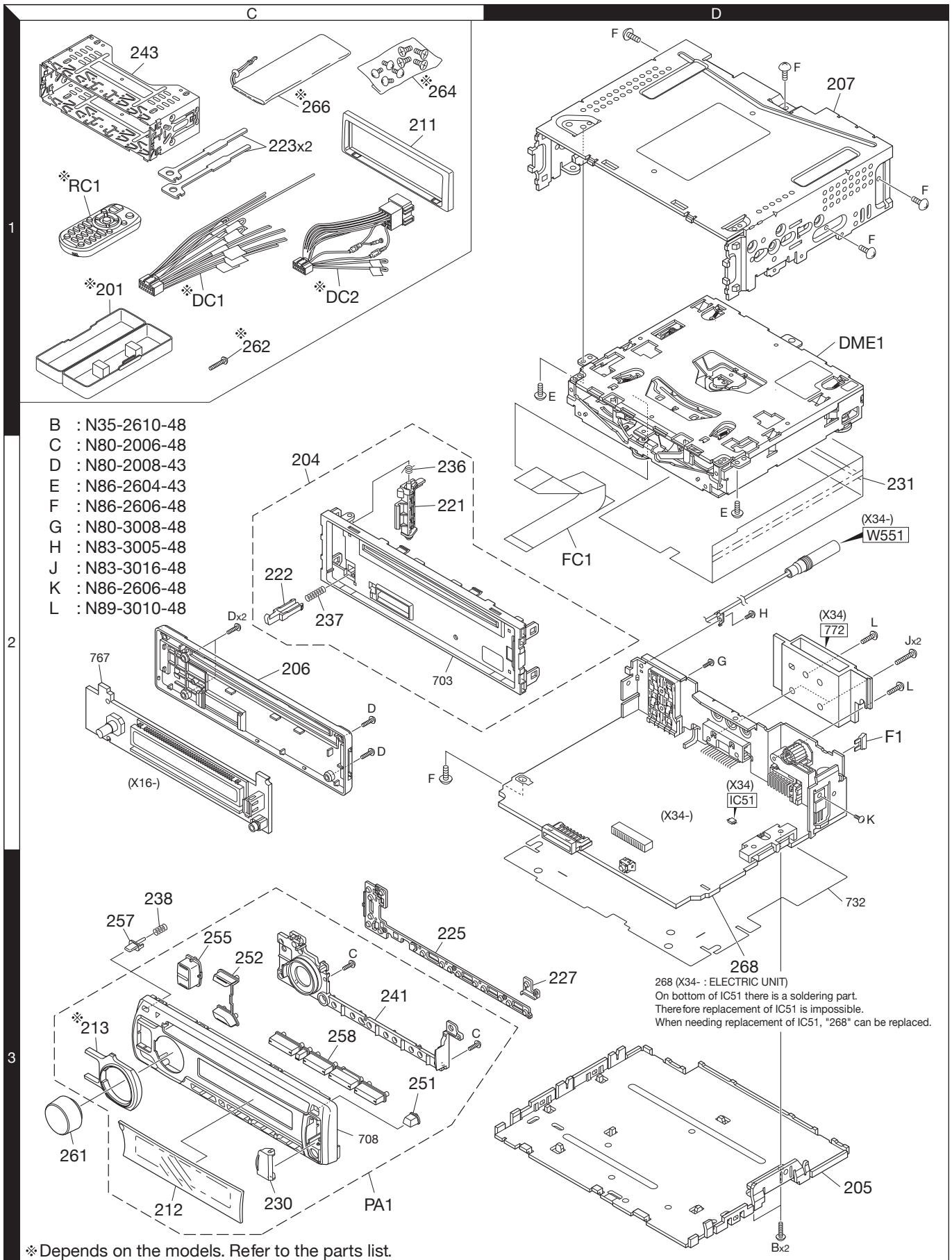

Parts with the exploded numbers larger than 700 are not supplied.

# PARTS LIST

\* New parts

Parts without **Parts No.** are not supplied.

Les articles non mentionnés dans le **Parts No.** ne sont pas fournis.

Teile ohne **Parts No.** werden nicht geliefert.

Ref. No.	A d d	N e w	Parts No.	Description	Desti- nation
<b>KDC-4047Ux/414Ux/MP245U/U3046/U346/U4046</b>					
201	1C		A02-2755-23	PLASTIC CABINET ASSY	M2M3
204	2C	*	A22-3260-13	SUB PANEL ASSY	
205	3D	*	A40-1371-11	BOTTOM PLATE	
206	2C	*	A46-1901-01	REAR COVER	
207	1D	*	A52-1126-01	TOP COVER	
PA1	3C	*	A64-5001-12	PANEL ASSY	K1
PA1	3C	*	A64-5002-12	PANEL ASSY	E2E3
PA1	3C	*	A64-5003-12	PANEL ASSY	E4
PA1	3C	*	A64-5004-12	PANEL ASSY	E5
PA1	3C	*	A64-5008-12	PANEL ASSY	M2
PA1	3C	*	A64-5009-12	PANEL ASSY	M3
PA1	3C	*	A64-5016-12	PANEL ASSY	C2
PA1	3C	*	A64-5131-12	PANEL ASSY	M4
PA1	3C	*	A64-5132-12	PANEL ASSY	M5
RC1	1C	*	A70-2104-05	REMOTE CONTROLLER ASSY (RC-405)	K1M2M3
-		*	B64-4526-00	INST. MANUAL (ENGLISH)	E3E4E5
-		*	B64-4526-00	INST. MANUAL (ENGLISH)	M4M5E2
-		*	B64-4527-00	INST. MANUAL (FRE.GER.DUT.)	E2E3E4
-		*	B64-4528-00	INST. MANUAL (ITA.SPA.POR.)	E2E3E4
-		*	B64-4529-00	INST. MANUAL (ENG.FRE.SPA.)	K1
-		*	B64-4530-00	INST. MANUAL (UKRAINIAN)	E2E3E4
-		*	B64-4530-00	INST. MANUAL (UKRAINIAN)	E5
-		*	B64-4531-00	INST. MANUAL (ENG.ARA.)	M2M3
-		*	B64-4532-00	INST. MANUAL (S-CHINESE)	C2
211	1C		B07-3270-01	ESCUTCHEON	
212	3C	*	B10-5324-01	FRONT GLASS	K1
212	3C	*	B10-5325-01	FRONT GLASS	E2E3
212	3C	*	B10-5326-01	FRONT GLASS	E4
212	3C	*	B10-5327-01	FRONT GLASS	E5
212	3C	*	B10-5331-01	FRONT GLASS	M2
212	3C	*	B10-5332-01	FRONT GLASS	M3
212	3C	*	B10-5339-01	FRONT GLASS	C2
212	3C	*	B10-5380-01	FRONT GLASS	M4
212	3C	*	B10-5381-01	FRONT GLASS	M5
213	3C	*	B07-3327-03	ESCUTCHEON	M3C2
213	3C	*	B07-3328-03	ESCUTCHEON	M5E4
221	2C	*	D10-7099-03	LEVER	
222	2C	*	D10-7098-03	LEVER	
223	1C	*	D10-7106-04	LEVER	
225	3C	*	E29-2153-02	CONDUCTIVE RUBBER	
227	3D	*	E29-2154-04	CONDUCTIVE RUBBER	
△ DC1	1C		E30-6798-05	DC CORD	K1M2
△ DC1	1C	*	E30-6933-05	DC CORD	M3C2
△ DC2	1C		E30-6800-05	DC CORD	E5
△ DC2	1C	*	E30-6934-05	DC CORD	E3E4
△ DC2	1C	*	E30-6934-05	DC CORD	M4M5E2
FC1	2D	*	E39-1077-05	FLAT CABLE	
230	3C	*	F07-2219-03	COVER	
231	2D	*	F11-1874-03	SHIELDING COVER	
△ F1	2D		F52-0023-05	FUSE (MINI BLADE TYPE) (10A)	
236	2C	*	G01-4750-04	TORSION COIL SPRING	

Ref. No.	A d d	N e w	Parts No.	Description	Desti- nation
237	2C	*	G01-4749-04	COMPRESSION SPRING	
238	3C	*	G01-3244-04	COMPRESSION SPRING	
-		*	H54-4724-03	ITEM CARTON CASE	K1
-		*	H54-4727-03	ITEM CARTON CASE	E2
-		*	H54-4728-03	ITEM CARTON CASE	E3
-		*	H54-4729-03	ITEM CARTON CASE	E4
-		*	H54-4730-03	ITEM CARTON CASE	E5
-		*	H54-4734-03	ITEM CARTON CASE	M2
-		*	H54-4735-03	ITEM CARTON CASE	M3
-		*	H54-4759-03	ITEM CARTON CASE	M4
-		*	H54-4760-03	ITEM CARTON CASE	M5
-		*	H54-4822-03	ITEM CARTON CASE	C2
241	3C	*	J19-7287-11	HOLDER	
243	1C		J22-0789-03	MOUNTING HARDWARE ASSY	
251	3C	*	K24-5041-04	PUSH KNOB (EJECT)	
252	3C	*	K25-1983-03	PUSH KNOB (SRC/BAND)	
255	3C	*	K24-5043-03	PUSH KNOB (SEARCH)	
257	3C	*	K24-5042-04	PUSH KNOB (RELEASE)	
258	3C	*	K25-1982-02	PUSH KNOB (PRESET)	
261	3C		K28-0337-04	KNOB ASSY (VOL)	E3E4
261	3C		K28-0337-04	KNOB ASSY (VOL)	K1M3M4
261	3C		K28-0337-04	KNOB ASSY (VOL)	M5C2E2
261	3C	*	K28-0395-04	KNOB ASSY (VOL)	M2E5
262	1C		N84-4016-48	PAN HEAD TAPTITE SCREW	C2
262	1C		N84-4016-48	PAN HEAD TAPTITE SCREW	K1M2M3
264	1C		N99-1757-15	SCREW SET	C2
264	1C		N99-1757-15	SCREW SET	K1M2M3
B	3D		N35-2610-48	BINDING HEAD MACHINE SCREW	
C	3C		N80-2006-48	PAN HEAD TAPTITE SCREW	
D	2C		N80-2008-43	PAN HEAD TAPTITE SCREW	
E	2D		N86-2604-43	BINDING HEAD TAPTITE SCREW	
F	1D		N86-2606-48	BINDING HEAD TAPTITE SCREW	
266	1C		W01-1710-05	CARRYING CASE	E2E3E4
266	1C		W01-1710-05	CARRYING CASE	E5
266	1C		W01-1710-05	CARRYING CASE	K1M4M5
268	3D	*	X34-6600-11	ELECTRIC UNIT (for IC51)	K1
268	3D	*	X34-6600-22	ELECTRIC UNIT (for IC51)	M2
268	3D	*	X34-6600-23	ELECTRIC UNIT (for IC51)	M3C2
268	3D	*	X34-6602-72	ELECTRIC UNIT (for IC51)	E3E4
268	3D	*	X34-6602-72	ELECTRIC UNIT (for IC51)	M4M5E2
268	3D	*	X34-6602-73	ELECTRIC UNIT (for IC51)	E5
DME1	1D		X92-6370-00	MECHANISM ASSY (DXM-9B20W)	
<b>SWITCH UNIT (X16-675x-xx)</b>					
D51			B30-1566-05	LED (1608,RED)	
D52			B30-1780-05	LED (1608,PG)	E5
D52			B30-1780-05	LED (1608,PG)	M2C2E3
D55 ,56			B30-1780-05	LED (1608,PG)	E5
D55 ,56			B30-1780-05	LED (1608,PG)	M2C2E3
D56 -62			B30-1779-05	LED (1608,SR)	K1M3M4
D56 -62			B30-1779-05	LED (1608,SR)	M5E2E4
D58			B30-1780-05	LED (1608,PG)	E5
D58			B30-1780-05	LED (1608,PG)	M2C2E3
D62 -75			B30-1780-05	LED (1608,PG)	E5

**K1** : KDC-MP245U    **M2** : KDC-U3046    **M3** : KDC-U346    **M4** : KDC-4047UM    **M5** : KDC-414UM  
**C2** : KDC-U4046    **E2** : KDC-4047UA    **E3** : KDC-4047UG    **E4** : KDC-414UA    **E5** : KDC-4047UGY

△ Indicates safety critical components.



# PARTS LIST

## SWITCH UNIT (X16-675x-xx)

Ref. No.	Add	New	Parts No.	Description	Destination
D62 -75			B30-1780-05	LED (1608,PG)	M2C2E3
D65			B30-1779-05	LED (1608,SR)	K1M3M4
D65			B30-1779-05	LED (1608,SR)	M5E2E4
D91 -93			B30-1779-05	LED (1608,SR)	K1M3M4
D91 -93			B30-1779-05	LED (1608,SR)	M5E2E4
D92			B30-1780-05	LED (1608,PG)	E5
D92			B30-1780-05	LED (1608,PG)	M2C2E3
C11			CK73GB0J105K	CHIP C 1.0UF K	
C12			CK73HB1A104K	CHIP C 0.10UF K	
C13 -16			CC73GCH1H471J	CHIP C 470PF J	
C21			CK73GB0J105K	CHIP C 1.0UF K	K1M2M3
C21			CK73GB0J105K	CHIP C 1.0UF K	M4M5C2
C41 ,42			CK73HB1E103K	CHIP C 0.010UF K	
C81 ,82			CC73GCH1H330J	CHIP C 33PF J	
C83			CK73GB1H472K	CHIP C 4700PF K	
C84			CK73GB1H103K	CHIP C 0.010UF K	
J1	*		E59-0860-05	RECTANGULAR PLUG	
J2	*		E11-0669-05	3.5D PHONE JACK	
J3	*		E58-1129-05	RECTANGULAR RECEPTACLE	
CP11			RK74GA1J101J	CHIP-COM 100 J 1/16W	
R11			RK73HB1J473J	CHIP R 47K J 1/16W	
R12			RK73HB1J221J	CHIP R 220 J 1/16W	
R14			RK73HB1J472J	CHIP R 4.7K J 1/16W	
R15			RK73GB2A4R7J	CHIP R 4.7 J 1/10W	
R16			RK73HB1J102J	CHIP R 1.0K J 1/16W	
R21			RK73HB1J104J	CHIP R 100K J 1/16W	K1M2M3
R21			RK73HB1J104J	CHIP R 100K J 1/16W	M4M5C2
R22			RK73GB2A101J	CHIP R 100 J 1/10W	K1M2M3
R22			RK73GB2A101J	CHIP R 100 J 1/10W	M4M5C2
R23			RK73HB1J104J	CHIP R 100K J 1/16W	E2E3E4
R23			RK73HB1J104J	CHIP R 100K J 1/16W	E5
R24			RK73HB1J000J	CHIP R 0.0 J 1/16W	
R31			RK73PB2H120J	CHIP R 12 J 1/2W	
R51			RK73EB2E821J	CHIP R 820 J 1/4W	
R52			RK73FB2B621J	CHIP R 620 J 1/8W	K1M3M4
R52			RK73FB2B621J	CHIP R 620 J 1/8W	M5E2E4
R52 ,53			RK73FB2B621J	CHIP R 620 J 1/8W	E5
R52 ,53			RK73FB2B621J	CHIP R 620 J 1/8W	M2C2E3
R53			RK73FB2B561J	CHIP R 560 J 1/8W	K1M3M4
R53			RK73FB2B561J	CHIP R 560 J 1/8W	M5E2E4
R54 -56			RK73FB2B391J	CHIP R 390 J 1/8W	E5
R54 -56			RK73FB2B391J	CHIP R 390 J 1/8W	M2C2E3
R54 -57			RK73FB2B621J	CHIP R 620 J 1/8W	K1M3M4
R54 -57			RK73FB2B621J	CHIP R 620 J 1/8W	M5E2E4
R58			RK73FB2B391J	CHIP R 390 J 1/8W	E5
R58			RK73FB2B391J	CHIP R 390 J 1/8W	M2C2E3
R61			RK73FB2B391J	CHIP R 390 J 1/8W	E5
R61			RK73FB2B391J	CHIP R 390 J 1/8W	M2C2E3
R75			RK73GB2A271J	CHIP R 270 J 1/10W	K1M3M4
R75			RK73GB2A271J	CHIP R 270 J 1/10W	M5E2E4
R81 ,82			RK73GB2A220J	CHIP R 22 J 1/10W	
S1			T99-0484-05	ROTARY ENCODER	

Ref. No.	Add	New	Parts No.	Description	Destination
D81		*	HZM6.8ZMWA-E	ZENER DIODE	
D82			DA204U	DIODE	
ED1		*	3-BT-267N	FLUORESCENT INDICATOR TUBE	
IC1			BU9754KV-E2	MOS-IC	K1M2M3
IC2			PIC95603	ANALOGUE IC	
IC2			PIC95603	ANALOGUE IC	M4M5C2
<b>CD PLAYER UNIT (X32-6250-00) IN CD MECHA</b>					
C1			CK73FB0J106K	CHIP C 10UF K	
C3			CC73GCH1H680J	CHIP C 68PF J	
C4			CK73GB1A105K	CHIP C 1.0UF K	
C6			CK73FB1C105K	CHIP C 1.0UF K	
C8			CK73GB1H222K	CHIP C 2200PF K	
C9 ,10			CK73GB1C104K	CHIP C 0.10UF K	
C11			CK73GB1H153K	CHIP C 0.015UF K	
C12			CK73GB1C104K	CHIP C 0.10UF K	
C13			CK73GB1H332K	CHIP C 3300PF K	
C14			CK73GB1H103K	CHIP C 0.010UF K	
C15			CK73GB1C333K	CHIP C 0.033UF K	
C16			CK73GB1C104K	CHIP C 0.10UF K	
C18			CK73GB1H153K	CHIP C 0.015UF K	
C19			CK73GB1H103K	CHIP C 0.010UF K	
C20			CK73GB1C104K	CHIP C 0.10UF K	
C22			CK73GB1H103K	CHIP C 0.010UF K	
C23			CK73GB1H153K	CHIP C 0.015UF K	
C24			CC73GCH1H470J	CHIP C 47PF J	
C25			CK73GB1C104K	CHIP C 0.10UF K	
C26			CK73GB1A105K	CHIP C 1.0UF K	
C27			CK73GB1C104K	CHIP C 0.10UF K	
C29 ,30			CK73GB1C104K	CHIP C 0.10UF K	
C31			CK73GB1A105K	CHIP C 1.0UF K	
C36			CK73GB1A105K	CHIP C 1.0UF K	
C41 ,42			CK73GB1C104K	CHIP C 0.10UF K	
C43 ,44			CK73GB1H102K	CHIP C 1000PF K	
C45			CK73GB1H103K	CHIP C 0.010UF K	
C46			CK73GB1A105K	CHIP C 1.0UF K	
C47			CC73GCH1H560J	CHIP C 56PF J	
C48			CC73GCH1H101J	CHIP C 100PF J	
C49			CK73GB1A105K	CHIP C 1.0UF K	
C50			CK73FB1A225K	CHIP C 2.2UF K	
C51			CK73FB0J106K	CHIP C 10UF K	
C54			CK73FB0J106K	CHIP C 10UF K	
C57			CK73GB1C104K	CHIP C 0.10UF K	
C59			CK73GB1H472K	CHIP C 4700PF K	
C61			CK73GB1C104K	CHIP C 0.10UF K	
C101			CK73GB1A105K	CHIP C 1.0UF K	
C103			CK73GB1C104K	CHIP C 0.10UF K	
CN1			E41-2954-05	FLAT CABLE CONNECTOR	
CN2			E41-2630-05	FLAT CABLE CONNECTOR	
X1			L78-1221-05	RESONATOR (16.93MHZ)	
CP7			RK74GB1J103J	CHIP-COM 10K J 1/16W	
R1			RK73GB2A560J	CHIP R 56 J 1/10W	
R2			RK73GB2A472J	CHIP R 4.7K J 1/10W	
R3			RK73GB2A4R7J	CHIP R 4.7 J 1/10W	

**K1** : KDC-MP245U **M2** : KDC-U3046 **M3** : KDC-U346 **M4** : KDC-4047UM **M5** : KDC-414UM  
**C2** : KDC-U4046 **E2** : KDC-4047UA **E3** : KDC-4047UG **E4** : KDC-414UA **E5** : KDC-4047UGY

△ Indicates safety critical components.

# PARTS LIST

## CD PLAYER UNIT (X32-6250-00) IN CD MECHA

Ref. No.	Add	New	Parts No.	Description	Destination
R4			RK73GB2A104J	CHIP R 100K J 1/10W	
R5			RK73GB2A225J	CHIP R 2.2M J 1/10W	
R6			RK73GB2A102J	CHIP R 1.0K J 1/10W	
R7			RK73GB2A221J	CHIP R 220 J 1/10W	
R8			RK73GB2A622J	CHIP R 6.2K J 1/10W	
R9			RK73GB2A913J	CHIP R 91K J 1/10W	
R10			RK73GB2A334J	CHIP R 330K J 1/10W	
R11			RK73GB2A153J	CHIP R 15K J 1/10W	
R13			RK73GB2A104J	CHIP R 100K J 1/10W	
R14			RK73GB2A103J	CHIP R 10K J 1/10W	
R15			RK73GB2A101J	CHIP R 100 J 1/10W	
R17 ,18			RK73GB2A103J	CHIP R 10K J 1/10W	
R25			RK73GB2A103J	CHIP R 10K J 1/10W	
R27			RK73EB2E4R7J	CHIP R 4.7 J 1/4W	
R39			RK73GB2A105J	CHIP R 1.0M J 1/10W	
R40			RK73GB2A681J	CHIP R 680 J 1/10W	
R43 ,44			RK73GB2A4R7J	CHIP R 4.7 J 1/10W	
R49			RK73GB2A393J	CHIP R 39K J 1/10W	
R50			RK73GB2A363J	CHIP R 36K J 1/10W	
R51			RK73GB2A102J	CHIP R 1.0K J 1/10W	
R52 -58			RK73GB2A101J	CHIP R 100 J 1/10W	
R59			RK73GB2A204J	CHIP R 200K J 1/10W	
R64			RK73GB2A223J	CHIP R 22K J 1/10W	
R65			RK73GB2A333J	CHIP R 33K J 1/10W	
R69 -73			RK73GB2A101J	CHIP R 100 J 1/10W	
R74 ,75			RK73GB2A103J	CHIP R 10K J 1/10W	
R76			RK73GB2A202J	CHIP R 2.0K J 1/10W	
R102			RK73GB2A102J	CHIP R 1.0K J 1/10W	
S1 ,2			S68-0924-05	PUSH SWITCH	
D2			DAP202U	DIODE	
D3 ,4			DA204U	DIODE	
IC3			BD8222EFV	ANALOGUE IC	
IC4			TC94A92FG-301	MOS-IC	
IC5			XC6415S001P1	MOS-IC	
Q1			2SB0970	TRANSISTOR	
Q14			RUE003N02	FET	
<b>ELECTRIC UNIT (X34-660x-xx)</b>					
C1		*	C90-6906-05	ELECTRO 3300UF 16WV	
C2			CD04AV1C220M	ELECTRO 22UF 16WV	
C3			CK73GB1H104K	CHIP C 0.10UF K	E2E3E4
C3			CK73GB1H104K	CHIP C 0.10UF K	E5
C3			CK73GB1H104K	CHIP C 0.10UF K	K1M4M5
C3 ,4			CK73GB1H104K	CHIP C 0.10UF K	M2M3C2
C5			CD04BN1C221M	ELECTRO 220UF 16WV	
C7			CD04AV0J101M	ELECTRO 100UF 6.3WV	
C9			CK73GB1C104K	CHIP C 0.10UF K	
C11			CK73FB1A225K	CHIP C 2.2UF K	
C14			CK73GB1C104K	CHIP C 0.10UF K	
C17			CK73GB1C104K	CHIP C 0.10UF K	
C55			CK73FB0J106K	CHIP C 10UF K	
C56			CK73GB1H102K	CHIP C 1000PF K	
C57			CK73GB1A474K	CHIP C 0.47UF K	
C58			CK73FB0J106K	CHIP C 10UF K	

Ref. No.	Add	New	Parts No.	Description	Destination
C59 ,60			CK73GB1C104K	CHIP C 0.10UF K	
C64			CD04BK1A221M	ELECTRO 220UF 10WV	
C65			CK73GB1H103K	CHIP C 0.010UF K	
C66 ,67			CK73GB1A105K	CHIP C 1.0UF K	
C68			CD04AV0J470M	ELECTRO 47UF 6.3WV	
C69			CK73GB1C104K	CHIP C 0.10UF K	
C73			CK73EB1H475K	CHIP C 4.7UF K	
C75			CC73GCH1H390J	CHIP C 39PF J	
C101,102			CK73GB1H103K	CHIP C 0.010UF K	
C201			CK73GB1A105K	CHIP C 1.0UF K	
C202			CC73GCH1H270J	CHIP C 27PF J	
C203			CC73GCH1H220J	CHIP C 22PF J	
C204			CK73GB1C104K	CHIP C 0.10UF K	
C207,208			CK73GB1C104K	CHIP C 0.10UF K	
C301,302			CD04AV1HR47M	ELECTRO 0.47UF 50WV	
C303			CC73GCH1H150J	CHIP C 15PF J	
C306,307			CK73GB1C104K	CHIP C 0.10UF K	
C308			CD04AV0J470M	ELECTRO 47UF 6.3WV	
C309			CK73GB1H103K	CHIP C 0.010UF K	
C310,311			CK73GB1H102K	CHIP C 1000PF K	
C315,316			CC73GCH1H100D	CHIP C 10PF D	
C401			CD04AV1C470M	ELECTRO 47UF 16WV	
C403			CD04AV1H010M	ELECTRO 1UF 50WV	
C404-407			CK73GB1A105K	CHIP C 1.0UF K	
C501			CK73GB1H102K	CHIP C 1000PF K	
C502			CK73GB1A105K	CHIP C 1.0UF K	
C505			CK73GB1A224K	CHIP C 0.22UF K	
C506			CK73GB1C104K	CHIP C 0.10UF K	
C507			CC73GCH1H090D	CHIP C 9.0PF D	
C509-511			CK73GB1A105K	CHIP C 1.0UF K	
C512-514			CK73GB1H103K	CHIP C 0.010UF K	
C515			CK73GB1C104K	CHIP C 0.10UF K	
C516			CK73GB1H103K	CHIP C 0.010UF K	
C517			CK73GB1C104K	CHIP C 0.10UF K	
C518			CK73GB1H102K	CHIP C 1000PF K	
C519			CD04AV1C470M	ELECTRO 47UF 16WV	
C520			CK73GB1C104K	CHIP C 0.10UF K	
C523			CK73GB1H102K	CHIP C 1000PF K	
C524			CK73GB1A224K	CHIP C 0.22UF K	
C525			CC73GCH1H270J	CHIP C 27PF J	
C527			CC73GCH1H150J	CHIP C 15PF J	
C528			CC73GCH1H471J	CHIP C 470PF J	E2E3E4
C528			CC73GCH1H471J	CHIP C 470PF J	E5
C528			CC73GCH1H471J	CHIP C 470PF J	K1M4M5
C530			CK73GB1H102K	CHIP C 1000PF K	
C531			CC73GCH1H070D	CHIP C 7.0PF D	E2E3E4
C531			CC73GCH1H070D	CHIP C 7.0PF D	E5
C531			CC73GCH1H070D	CHIP C 7.0PF D	K1M4M5
C531,532			CC73GCH1H040C	CHIP C 4.0PF C	M2M3C2
C532			CC73GCH1H060D	CHIP C 6.0PF D	E2E3E4
C532			CC73GCH1H060D	CHIP C 6.0PF D	E5
C532			CC73GCH1H060D	CHIP C 6.0PF D	K1M4M5
C533			CC73GCH1H020C	CHIP C 2.0PF C	E2E3E4
C533			CC73GCH1H020C	CHIP C 2.0PF C	E5
C533			CC73GCH1H020C	CHIP C 2.0PF C	K1M4M5

**K1** : KDC-MP245U **M2** : KDC-U3046 **M3** : KDC-U346 **M4** : KDC-4047UM **M5** : KDC-414UM  
**C2** : KDC-U4046 **E2** : KDC-4047UA **E3** : KDC-4047UG **E4** : KDC-414UA **E5** : KDC-4047UGY

△Indicates safety critical components.

# PARTS LIST

## ELECTRIC UNIT (X34-660x-xx)

Ref. No.	Add	New	Parts No.	Description	Destination	Ref. No.	Add	New	Parts No.	Description	Destination
C534			CC73GCH1H471J	CHIP C 470PF J	M2M3C2	L507		*	L40-1891-58	SMALL FIXED INDUCTOR (1.8UH)	E2E3E4
C535			CC73GCH1H221J	CHIP C 220PF J		L507		*	L40-1891-58	SMALL FIXED INDUCTOR (1.8UH)	E5
C542			CK73GB1H103K	CHIP C 0.010UF K	E3E4E5	L507		*	L40-1891-58	SMALL FIXED INDUCTOR (1.8UH)	K1M4M5
C542			CK73GB1H103K	CHIP C 0.010UF K	M4M5E2	L507		*	L40-3391-58	SMALL FIXED INDUCTOR (3.3UH)	M2M3C2
C544			CC73GCH1H331J	CHIP C 330PF J	E3E4E5	L508		*	L40-4781-58	SMALL FIXED INDUCTOR	
C544			CC73GCH1H331J	CHIP C 330PF J	M4M5E2	L551		*	L31-0993-05	FM-RF COIL	
C545,546			CC73GCH1H120J	CHIP C 12PF J	E3E4E5	X1		*	L78-1235-05	RESONATOR (16.0MHZ)	
C545,546			CC73GCH1H120J	CHIP C 12PF J	M4M5E2	X2		*	L77-2920-05	CRYSTAL RESONATOR	
C548			CK73GB0J225K	CHIP C 2.2UF K	E3E4E5	X3		*	L77-3825-05	CRYSTAL RESONATOR (4.332MHZ)	E3E4E5
C548			CK73GB0J225K	CHIP C 2.2UF K	M4M5E2	X3		*	L77-3825-05	CRYSTAL RESONATOR (4.332MHZ)	M4M5E2
C549			CK73GB1H103K	CHIP C 0.010UF K		X501		*	L77-3824-05	CRYSTAL RESONATOR (4.000MHZ)	
C703,704			CD04AV1V100M	ELECTRO 10UF 35WV	E2E3E4	X900		*	L77-2921-15	CRYSTAL RESONATOR (32.768KHZ)	
C703,704			CD04AV1V100M	ELECTRO 10UF 35WV	K1M2M3	X901		*	L77-3826-05	CRYSTAL RESONATOR (9.00MHZ)	
C703,704			CD04AV1V100M	ELECTRO 10UF 35WV	M4M5C2						
C801-804			CK73GB1A224K	CHIP C 0.22UF K		G	2D		N80-3008-48	PAN HEAD TAPTITE SCREW	E2E3E4
C805			CD04AV1V100M	ELECTRO 10UF 35WV		G	2D		N80-3008-48	PAN HEAD TAPTITE SCREW	K1M2M3
C806,807			CK73GB1A105K	CHIP C 1.0UF K		G	2D		N80-3008-48	PAN HEAD TAPTITE SCREW	M4M5C2
C809			CK73GB1A105K	CHIP C 1.0UF K		H	2D		N83-3005-48	PAN HEAD TAPTITE SCREW	
C851-858			CK73GB1H472K	CHIP C 4700PF K		J	2D		N83-3016-48	PAN HEAD TAPTITE SCREW	
C859			CK73GB1H104K	CHIP C 0.10UF K		K	2D		N86-2606-48	BINDING HEAD TAPTITE SCREW	
C901			CK73GB1H103K	CHIP C 0.010UF K		L	2D		N89-3010-48	BINDING HEAD TAPTITE SCREW	
C902			CC73GCH1H180J	CHIP C 18PF J		R1			RD14BB2C102J	RD 1.0K J 1/6W	
C903			CC73GCH1H220J	CHIP C 22PF J		R2 ,3			RK73GB2A103J	CHIP R 10K J 1/10W	
C904-906			CK73GB1H103K	CHIP C 0.010UF K		R5			RK73GB2A103J	CHIP R 10K J 1/10W	
C908,909			CK73GB1H103K	CHIP C 0.010UF K		R15			RD14DB2H7R5J	SMALL-RD 7.5 J 1/2W	
C911,912			CC73GCH1H100D	CHIP C 10PF D		R19			RK73GB2A100J	CHIP R 10 J 1/10W	
C914			CK73GB1H103K	CHIP C 0.010UF K		R53			RK73GH2A153D	CHIP R 15K D 1/10W	
C915			CK73GB1A105K	CHIP C 1.0UF K		R54			RK73GH2A823D	CHIP R 82K D 1/10W	
C916,917			CK73FB0J106K	CHIP C 10UF K		R55			RK73GB2A103J	CHIP R 10K J 1/10W	
C918			CK73GB1A105K	CHIP C 1.0UF K		R56			RK73GH2A223D	CHIP R 22K D 1/10W	
C922			CK73FB0J106K	CHIP C 10UF K		R57			RK73GH2A333D	CHIP R 33K D 1/10W	
C955			CC73GCH1H070D	CHIP C 7.0PF D		R58			RK73GB2A473J	CHIP R 47K J 1/10W	
CN2			E41-1828-05	FLAT CABLE CONNECTOR		R59			RK73GB2A203J	CHIP R 20K J 1/10W	
△ J1			E58-0991-05	RECTANGULAR RECEPTACLE		R62			RK73GB2A223J	CHIP R 22K J 1/10W	
J3			E58-1060-15	RECTANGULAR RECEPTACLE		R101			RD14BB2C472J	RD 4.7K J 1/6W	K1
J5		*	E63-0974-05	PIN JACK	E2E3E4	R101,102			RD14BB2C472J	RD 4.7K J 1/6W	E3E4E5
J5		*	E63-0974-05	PIN JACK	K1M2M3	R101,102			RD14BB2C472J	RD 4.7K J 1/6W	M2M3M4
J5		*	E63-0974-05	PIN JACK	M4M5C2	R106			RD14BB2C332J	RD 3.3K J 1/6W	M5C2E2
W551	2D		E30-6803-05	CORD WITH PLUG		R107			RD14BB2C333J	RD 33K J 1/6W	
△ L1			L33-2459-05	CHOKE COIL ASSY		R108			RK73GB2A103J	CHIP R 10K J 1/10W	
L51			L33-2462-05	SMALL FIXED INDUCTOR (22UH)		R109			RK73GB2A223J	CHIP R 22K J 1/10W	
L71			L92-0639-05	CHIP FERRITE		R110			RK73FB2B683J	CHIP R 68K J 1/8W	
L73			L92-0639-05	CHIP FERRITE		R111			RK73GB2A473J	CHIP R 47K J 1/10W	
L401			L40-4791-58	SMALL FIXED INDUCTOR		R112			RD14BB2C203J	RD 20K J 1/6W	
L501			L40-4791-58	SMALL FIXED INDUCTOR		R113			RK73GB2A104J	CHIP R 100K J 1/10W	
L502,503			L33-1031-05	SMALL FIXED INDUCTOR		R114,115			RK73GB2A103J	CHIP R 10K J 1/10W	
L504		*	L40-2781-58	SMALL FIXED INDUCTOR (0.27UH)		R116,117			RK73GB2A682J	CHIP R 6.8K J 1/10W	
L505		*	L40-4791-58	SMALL FIXED INDUCTOR	E2E3E4	R118			RD14BB2C103J	RD 10K J 1/6W	
L505		*	L40-4791-58	SMALL FIXED INDUCTOR	E5	R119			RK73GB2A473J	CHIP R 47K J 1/10W	
L505			L40-4791-58	SMALL FIXED INDUCTOR	K1M4M5	R120			RK73GB2A104J	CHIP R 100K J 1/10W	
L506			L40-1091-58	SMALL FIXED INDUCTOR (1.0UH)	M2M3C2	R151			RK73GB2A000J	CHIP R 0.0 J 1/10W	M2M3C2
L506		*	L40-4781-58	SMALL FIXED INDUCTOR	E2E3E4	R152			RK73GB2A000J	CHIP R 0.0 J 1/10W	E3E4E5
L506		*	L40-4781-58	SMALL FIXED INDUCTOR	E5	R152			RK73GB2A000J	CHIP R 0.0 J 1/10W	M4M5E2
L506		*	L40-4781-58	SMALL FIXED INDUCTOR	K1M4M5	R203,204			RK73GB2A103J	CHIP R 10K J 1/10W	

**K1** : KDC-MP245U    **M2** : KDC-U3046    **M3** : KDC-U346    **M4** : KDC-4047UM    **M5** : KDC-414UM  
**C2** : KDC-U4046    **E2** : KDC-4047UA    **E3** : KDC-4047UG    **E4** : KDC-414UA    **E5** : KDC-4047UGY

△ Indicates safety critical components.

# PARTS LIST

## ELECTRIC UNIT (X34-660x-xx)

Ref. No.	Ad	New	Parts No.	Description	Desti- nation	Ref. No.	Ad	New	Parts No.	Description	Desti- nation
R205			RK73GB2A473J	CHIP R 47K J 1/10W		R527			RK73GB2A4R7J	CHIP R 4.7 J 1/10W	
R207			RK73GB2A473J	CHIP R 47K J 1/10W		R541			RD14BB2C222J	RD 2.2K J 1/6W	E3E4E5
R208			RD14BB2C473J	RD 47K J 1/6W		R541			RD14BB2C222J	RD 2.2K J 1/6W	M4M5E2
R209-212			RK73GB2A471J	CHIP R 470 J 1/10W		R542,543			RK73GB2A222J	CHIP R 2.2K J 1/10W	E3E4E5
R218			RK73GB2A223J	CHIP R 22K J 1/10W		R542,543			RK73GB2A222J	CHIP R 2.2K J 1/10W	M4M5E2
R225			RK73GB2A223J	CHIP R 22K J 1/10W	E5	R544			RK73GB2A512J	CHIP R 5.1K J 1/10W	E3E4E5
R225			RK73GB2A473J	CHIP R 47K J 1/10W	E3E4	R544			RK73GB2A512J	CHIP R 5.1K J 1/10W	M4M5E2
R225			RK73GB2A473J	CHIP R 47K J 1/10W	M2M3M4	R545			RK73GB2A102J	CHIP R 1.0K J 1/10W	E3E4E5
R225			RK73GB2A473J	CHIP R 47K J 1/10W	M5C2E2	R545			RK73GB2A102J	CHIP R 1.0K J 1/10W	M4M5E2
R226			RK73GB2A223J	CHIP R 22K J 1/10W	M2M3C2	R650			RK73EB2E471J	CHIP R 470 J 1/4W	C2E2E3
R226			RK73GB2A473J	CHIP R 47K J 1/10W	K1E5	R650			RK73EB2E471J	CHIP R 470 J 1/4W	E4
R228			RK73GB2A473J	CHIP R 47K J 1/10W		R650			RK73EB2E471J	CHIP R 470 J 1/4W	M3M4M5
R231,232			RK73GB2A472J	CHIP R 4.7K J 1/10W		R713,714			RK73GB2A331J	CHIP R 330 J 1/10W	E2E3E4
R251,252			RK73GB2A101J	CHIP R 100 J 1/10W		R713,714			RK73GB2A331J	CHIP R 330 J 1/10W	K1M2M3
R253,254			RK73GB2A223J	CHIP R 22K J 1/10W		R713,714			RK73GB2A331J	CHIP R 330 J 1/10W	M4M5C2
R255-257			RK73GB2A101J	CHIP R 100 J 1/10W		R715,716			RK73GB2A223J	CHIP R 22K J 1/10W	E2E3E4
R258			RK73GB2A223J	CHIP R 22K J 1/10W		R715,716			RK73GB2A223J	CHIP R 22K J 1/10W	K1M2M3
R259			RK73GB2A101J	CHIP R 100 J 1/10W		R715,716			RK73GB2A223J	CHIP R 22K J 1/10W	M4M5C2
R260			RK73GB2A223J	CHIP R 22K J 1/10W		R717,718			RK73FB2B181J	CHIP R 180 J 1/8W	E2E3E4
R261-267			RK73GB2A101J	CHIP R 100 J 1/10W		R717,718			RK73FB2B181J	CHIP R 180 J 1/8W	K1M2M3
R268-271			RK73GB2A473J	CHIP R 47K J 1/10W		R717,718			RK73FB2B181J	CHIP R 180 J 1/8W	M4M5C2
R301			RK73GB2A222J	CHIP R 2.2K J 1/10W		R754			RK73EB2E000J	CHIP R 0.0 J 1/4W	
R302			RD14BB2C101J	RD 100 J 1/6W		R755,756			RK73GB2A000J	CHIP R 0.0 J 1/10W	
R306,307			RK73GB2A222J	CHIP R 2.2K J 1/10W		R802			RK73GB2A473J	CHIP R 47K J 1/10W	
R308			RK73GB2A100J	CHIP R 10 J 1/10W		R804			RK73GB2A331J	CHIP R 330 J 1/10W	
R317			RK73GB2A222J	CHIP R 2.2K J 1/10W		R805			RK73GB2A473J	CHIP R 47K J 1/10W	
R318			RK73GB2A472J	CHIP R 4.7K J 1/10W		R806			RK73GB2A512J	CHIP R 5.1K J 1/10W	
R319			RK73GB2A222J	CHIP R 2.2K J 1/10W		R808			RK73GB2A100J	CHIP R 10 J 1/10W	
R320			RK73GB2A472J	CHIP R 4.7K J 1/10W		R809			RD14BB2C102J	RD 1.0K J 1/6W	
R330			RD14BB2C101J	RD 100 J 1/6W		R811			RK73GB2A473J	CHIP R 47K J 1/10W	
R331			RK73GB2A392J	CHIP R 3.9K J 1/10W		R812			RK73GB2A432J	CHIP R 4.3K J 1/10W	
R332			RD14BB2C101J	RD 100 J 1/6W		R813			RK73EB2E000J	CHIP R 0.0 J 1/4W	
R333,334			RD14BB2C102J	RD 1.0K J 1/6W		R814			RK73GB2A000J	CHIP R 0.0 J 1/10W	
R335			RK73GB2A473J	CHIP R 47K J 1/10W		R900			RK73GB2A102J	CHIP R 1.0K J 1/10W	
R336-339			RK73GB2A222J	CHIP R 2.2K J 1/10W		R904			RK73GB2A223J	CHIP R 22K J 1/10W	
R340			RK73GB2A225J	CHIP R 2.2M J 1/10W		R905			RK73GB2A101J	CHIP R 100 J 1/10W	
R341			RK73GB2A222J	CHIP R 2.2K J 1/10W		R906			RK73GB2A223J	CHIP R 22K J 1/10W	
R342			RK73GB2A392J	CHIP R 3.9K J 1/10W		R907			RK73GB2A104J	CHIP R 100K J 1/10W	
R343			RD14BB2C102J	RD 1.0K J 1/6W		R908			RK73GB2A101J	CHIP R 100 J 1/10W	
R344,345			RD14BB2C4R7J	RD 4.7 J 1/6W		R909,910			RK73GB2A102J	CHIP R 1.0K J 1/10W	
R346			RD14BB2C2R2J	RD 2.2 J 1/6W		R911			RK73GB2A223J	CHIP R 22K J 1/10W	
R347			RK73GB2A102J	CHIP R 1.0K J 1/10W		R913			RK73GB2A101J	CHIP R 100 J 1/10W	
R348,349			RK73GB2A103J	CHIP R 10K J 1/10W		R914			RK73GB2A223J	CHIP R 22K J 1/10W	
R352,353			RD14BB2C100J	RD 10 J 1/6W		R915			RK73GB2A102J	CHIP R 1.0K J 1/10W	
R401			RK73GB2A103J	CHIP R 10K J 1/10W		R916			RK73GB2A101J	CHIP R 100 J 1/10W	
R402,403			RK73GB2A471J	CHIP R 470 J 1/10W		R917,918			RK73GB2A102J	CHIP R 1.0K J 1/10W	
R505			RK73GB2A472J	CHIP R 4.7K J 1/10W		R919			RK73GB2A101J	CHIP R 100 J 1/10W	
R506			RK73EB2E220J	CHIP R 22 J 1/4W		R920			RK73GB2A223J	CHIP R 22K J 1/10W	
R507,508			RK73GB2A221J	CHIP R 220 J 1/10W		R921			RK73GB2A101J	CHIP R 100 J 1/10W	
R513,514			RK73GB2A474J	CHIP R 470K J 1/10W	M2M3C2	R924			RK73GB2A101J	CHIP R 100 J 1/10W	
R513,514			RK73GB2A684J	CHIP R 680K J 1/10W	E2E3E4	R926			RK73GB2A000J	CHIP R 0.0 J 1/10W	
R513,514			RK73GB2A684J	CHIP R 680K J 1/10W	E5	R927			RK73GB2A105J	CHIP R 1.0M J 1/10W	
R515,516			RK73GB2A392J	CHIP R 3.9K J 1/10W	K1M4M5	R928			RK73GB2A223J	CHIP R 22K J 1/10W	
R525			RK73GB2A101J	CHIP R 100 J 1/10W	M2M3C2	R929			RK73GB2A100J	CHIP R 10 J 1/10W	
						R930			RK73GB2A153J	CHIP R 15K J 1/10W	

**K1** : KDC-MP245U    **M2** : KDC-U3046    **M3** : KDC-U346    **M4** : KDC-4047UM    **M5** : KDC-414UM  
**C2** : KDC-U4046    **E2** : KDC-4047UA    **E3** : KDC-4047UG    **E4** : KDC-414UA    **E5** : KDC-4047UGY

△Indicates safety critical components.



# PARTS LIST

## ELECTRIC UNIT (X34-660x-xx)

Ref. No.	Add	New	Parts No.	Description	Destination	Ref. No.	Add	New	Parts No.	Description	Destination
R931			RK73GB2A100J	CHIP R 10 J 1/10W		IC501		*	TEF6606T/V5S3	ANALOGUE IC	M4M5E2
R932			RK73GB2A153J	CHIP R 15K J 1/10W		IC900		*	92CD28AFG7EG0	MICROCONTROLLER IC	
R934-937			RK73GB2A101J	CHIP R 100 J 1/10W		Q2			KTA1046-P	TRANSISTOR	
R938			RK73GB2A223J	CHIP R 22K J 1/10W		Q3		*	2SC4154T1 (E,F)	TRANSISTOR	
R939,940			RK73GB2A101J	CHIP R 100 J 1/10W		Q11		*	RT1N241M-T111	TRANSISTOR	
R941			RK73GB2A332J	CHIP R 3.3K J 1/10W		Q12		*	RT1P241M-T111	TRANSISTOR	
R942			RK73GB2A101J	CHIP R 100 J 1/10W		Q13		*	RT1N241M-T111	TRANSISTOR	M2M3C2
R943			RK73GB2A332J	CHIP R 3.3K J 1/10W		Q14		*	RT1P241M-T111	TRANSISTOR	M2M3C2
R944-946			RK73GB2A101J	CHIP R 100 J 1/10W		Q53		*	RT1N441M-T111	TRANSISTOR	
R947			RK73GB2A223J	CHIP R 22K J 1/10W		Q101-103			2SC4081	TRANSISTOR	
R955			RK73GB2A101J	CHIP R 100 J 1/10W		Q104,105		*	RT1N441M-T111	TRANSISTOR	
R967			RK73GB2A223J	CHIP R 22K J 1/10W		Q301		*	RT1P144M-T111	TRANSISTOR	
R969			RK73FB2B2R2J	CHIP R 2.2 J 1/8W		Q705,706		*	RT1N430M-T111	TRANSISTOR	E2E3E4
R970			RK73GB2A000J	CHIP R 0.0 J 1/10W		Q705,706		*	RT1N430M-T111	TRANSISTOR	K1M2M3
R972			RK73GB2A102J	CHIP R 1.0K J 1/10W		Q705,706		*	RT1N430M-T111	TRANSISTOR	M4M5C2
R974			RK73GB2A000J	CHIP R 0.0 J 1/10W		Q707		*	RT1P241M-T111	TRANSISTOR	E2E3E4
S3	*		S70-0959-05	TACT SWITCH		Q707		*	RT1P241M-T111	TRANSISTOR	K1M2M3
D1			S2V60-5009F46	DIODE		Q707		*	RT1P241M-T111	TRANSISTOR	M4M5C2
D2			HZS9-E (A1)	ZENER DIODE		Q902		*	RT1N144M-T111	TRANSISTOR	
D3			D1F60-5063	DIODE		Q903		*	2SA1577	TRANSISTOR	
D4 ,5	*		HSS4148	DIODE	M2M3C2	Q905		*	RT1N441M-T111	TRANSISTOR	
D51			CMS14	DIODE		TH1			PRF18BE471QS2	POSITIVE RESISTOR	
D101-104			D1F60-5063	DIODE	E3E4E5	<b>MECHANISM ASSY (X92-6370-00) DXM-9B20W</b>					
D101-104			D1F60-5063	DIODE	M2M3M4	1	2B	*	A10-5450-63	CHASSIS ASSY	
D101-104			D1F60-5063	DIODE	M5C2E2	3	3B		A10-5452-41	CHASSIS	
D101,102			D1F60-5063	DIODE	K1	4	1B		A10-5453-32	CHASSIS	
D106-108			MTZJ6.8 (B)	ZENER DIODE		12	3A		D10-4993-52	LEVER	
D109			HZS5-E (B1)	ZENER DIODE		13	1B		D10-4991-22	ARM	
D110	*		MC2848-T111	DIODE		14	1B		D10-4992-13	ARM	
D304-306			HZS7-E (A3)	ZENER DIODE		15	2A		D10-4994-02	SLIDER	
D311,312			LVS10C270S030	VARIATOR		16	2A		D10-4995-03	SLIDER	
D313	*		HZM6.8ZMWA-E	ZENER DIODE		17	2B		D10-4996-02	SLIDER	
D401	*		HSS4148	DIODE		18	2A		D10-4997-03	LEVER	
D501			IMSA-6802-E	SURGE ABSORBER		19	1A		D10-4998-03	ARM	
D650			HZS7-E (A3)	ZENER DIODE	C2E2E3	20	2A		D10-4999-03	ARM	
D650			HZS7-E (A3)	ZENER DIODE	E4	21	2A		D10-7001-03	ARM	
D650			HZS7-E (A3)	ZENER DIODE	M3M4M5	22	2A		D10-7002-03	ARM	
D801,802	*		HSS4148	DIODE		23	2A		D10-7003-03	ARM	
IC1	*		W05-1544-00	MICROCONTROLLER IC		24	2A		D13-2445-04	GEAR	
IC2	*		E-TDA7718N	ANALOGUE IC		25	2A		D13-2446-04	GEAR	
IC4	*		BD49131-V4	ANALOGUE IC		27	2A		D13-2448-04	GEAR	
IC6	*		TB2926HQ	ANALOGUE IC		28	2A		D13-2449-04	GEAR	
IC7			E-TDA7478AD	ANALOGUE IC	E3E4E5	29	2A		D13-2450-04	GEAR	
IC7			E-TDA7478AD	ANALOGUE IC	M4M5E2	30	2A		D13-2451-04	GEAR	
IC8	*		XC6120N362N-G	MOS-IC		31	2A		D13-2452-04	GEAR	
IC51	2D		Impossible to repair	ANALOGUE IC (See exploded view)		32	2A		D13-2453-04	GEAR	
IC52	*		BD2224G	MOS-IC		33	2A		D13-2454-04	GEAR	
IC53			R1114N331B-TR	ANALOGUE IC		34	2A		D13-2455-04	GEAR	
IC251			TC74VHCT08AFT	MOS-IC		35	2B		D13-2456-03	RACK (GEAR)	
IC252			74LVC08APW	MOS-IC		36	2A		D14-1028-04	ROLLER	
IC501	*		TEF6606T/V5	ANALOGUE IC	C2	37	3A		D21-2507-04	SHAFT	
IC501	*		TEF6606T/V5	ANALOGUE IC	K1M2M3	38	2B		D21-2508-04	SHAFT	
IC501	*		TEF6606T/V5S3	ANALOGUE IC	E3E4E5	39	3A		D23-0963-04	RETAINER	
						40	3B		D39-0277-15	DAMPER	

**K1** : KDC-MP245U    **M2** : KDC-U3046    **M3** : KDC-U346    **M4** : KDC-4047UM    **M5** : KDC-414UM  
**C2** : KDC-U4046    **E2** : KDC-4047UA    **E3** : KDC-4047UG    **E4** : KDC-414UA    **E5** : KDC-4047UGY

△ Indicates safety critical components.

# PARTS LIST

## MECHANISM ASSY (X92-6370-00) DXM-9B20W

Ref. No.	A d d	N e w	Parts No.	Description	Desti- nation	Ref. No.	A d d	N e w	Parts No.	Description	Desti- nation
41		3B	D39-0278-15	DAMPER							
46		1B	G01-4682-34	TORSION COIL SPRING							
47		3A	G01-4683-24	EXTENSION SPRING							
48		2A	G01-4684-04	EXTENSION SPRING							
49		2B	G01-4685-04	EXTENSION SPRING							
50		1B	G01-4686-14	EXTENSION SPRING							
51		3A	G01-4688-14	EXTENSION SPRING							
52		3A	G01-4692-24	TORSION COIL SPRING							
53		2B	G02-1587-04	FLAT SPRING							
54		3A	G02-1588-04	FLAT SPRING							
55		1B	G13-1297-04	CUSHION							
56		1B	G13-1299-14	CUSHION							
57		1A	G16-1715-04	SHEET							
61		1B	J11-0675-03	CLAMPER							
64		2A	J19-7210-21	HOLDER							
65		2B	J19-7225-04	HOLDER							
66		1B	J22-0706-03	MOUNTING HARDWARE							
67		1A	J22-0707-12	MOUNTING HARDWARE							
68		1B	J90-1166-11	GUIDE							
69		2B	J90-1168-03	RAIL							
A		1A	N09-6108-15	TAPTITE SCREW (M2X3.5)							
B		2B	N09-6426-15	MACHINE SCREW							
C		2B	N09-6735-05	TAPTITE SCREW							
D		2B	N09-6737-15	MACHINE SCREW							
E		2B	N09-6738-15	TAPTITE SCREW							
F		2A	N19-2335-14	FLAT WASHER							
G		2B	N35-2003-48	BINDING HEAD MACHINE SCREW							
H		2B	N39-1720-48	PAN HEAD MACHINE SCREW							
76		2A	S68-0921-05	PUSH SWITCH							
DM1		2B	X94-2090-00	SPINDLE MOTOR ASSY							
DM2		2B	X94-2100-00	FEED MOTOR ASSY (LOAD/SLED)							
DPU1		2B	X93-2280-00	OPTICAL PICKUP ASSY							

# PARTS LIST

## CAPACITORS

CC 45 TH 1H 220 J  
1 2 3 4 5 6

- 1 = Type ... ceramic, electrolytic, etc.
- 2 = Shape ... round, square, etc.
- 3 = Temp. coefficient
- 4 = Voltage rating
- 5 = Value
- 6 = Tolerance

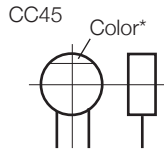

### • Capacitor value

- 010 = 1pF
- 100 = 10pF
- 101 = 100pF
- 102 = 1000pF = 0.001μF
- 103 = 0.01μF

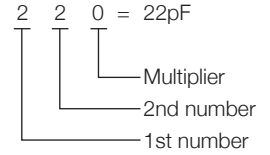

### • Temperature coefficient

1st Word	C	L	P	R	S	T	U
Color*	Black	Red	Orange	Yellow	Green	Blue	Violet
ppm/°C	0	-80	-150	-220	-330	-470	-750

2nd Word	G	H	J	K	L
ppm/°C	±30	±60	±120	±250	±500

Example : CC45TH = -470±60ppm/°C

### • Tolerance (More than 10pF)

Code	C	D	G	J	K	M	X	Z	P	No code
(%)	±0.25	±0.5	±2	±5	±10	±20	+40 -20	+80 -20	+100 -0	More than 10μF : -10~+50 Less than 4.7μF : -10~+75

### (Less than 10pF)

Code	B	C	D	F	G
(pF)	±0.1	±0.25	±0.5	±1	±2

### • Voltage rating

2nd word \ 1st word	A	B	C	D	E	F	G	H	J	K	V
0	1.0	1.25	1.6	2.0	2.5	3.15	4.0	5.0	6.3	8.0	-
1	10	12.5	16	20	25	31.5	40	50	63	80	35
2	100	125	160	200	250	315	400	500	630	800	-
3	1000	1250	1600	2000	2500	2150	4000	5000	6300	8000	-

### • Chip capacitors

- (EX) CC 73 F SL 1H 000 J  
1 2 3 4 5 6 7
- (Chip) (CH, RH, UJ, SL)
- (EX) CK 73 F F 1H 000 Z  
1 2 3 4 5 6 7
- (Chip) (B, F)
- Refer to the table above.
- 1 = Type
  - 2 = Shape
  - 3 = Dimension
  - 4 = Temp. coefficient
  - 5 = Voltage rating
  - 6 = Value
  - 7 = Tolerance

### • Dimension

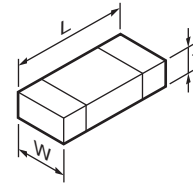

### Chip capacitor

Code	L	W	T
Empty	5.6±0.5	5.0±0.5	Less than 2.0
A	4.5±0.5	3.2±0.4	Less than 2.0
B	4.5±0.5	2.0±0.3	Less than 2.0
C	4.5±0.5	1.25±0.2	Less than 1.25
D	3.2±0.4	2.5±0.3	Less than 1.5
E	3.2±0.2	1.6±0.2	Less than 1.25
F	2.0±0.3	1.25±0.2	Less than 1.25
G	1.6±0.2	0.8±0.2	Less than 1.0
H	1.0±0.05	0.5±0.05	0.5±0.05

### Chip resistor

Code	L	W	T
E	3.2±0.2	1.6±0.2	1.0
F	2.0±0.3	1.25±0.2	1.0
G	1.6±0.2	0.8±0.2	0.5±0.1
H	1.0±0.05	0.5±0.05	0.35±0.05

### • Rating wattage

Code	Wattage	Code	Wattage	Code	Wattage
1J	1/16W	2C	1/6W	3A	1W
2A	1/10W	2E	1/4W	3D	2W
2B	1/8W	2H	1/2W		

## RESISTORS

### • Chip resistor (Carbon)

- (EX) RD 73 E B 2B 000 J  
1 2 3 4 5 6 7
- (Chip) (B, F)

### • Carbon resistor (Normal type)

- (EX) RD 14 B B 2C 000 J  
1 2 3 4 5 6 7

- 1 = Type
- 2 = Shape
- 3 = Dimension
- 4 = Temp. coefficient
- 5 = Rating wattage
- 6 = Value
- 7 = Tolerance

## SPECIFICATIONS (KDC-MP245U)

### FM tuner section

Frequency range (50kHz space)..... 87.5MHz~108.0MHz  
Usable sensitivity (S/N=26dB)..... 11.2dBf (1 $\mu$ V/75 $\Omega$ )  
Quieting Sensitivity (DIN S/N=46dB)..... 19.2dBf (2.5 $\mu$ V/75 $\Omega$ )  
Frequency response ( $\pm$ 3dB) .....30Hz~15kHz  
Signal to Noise ratio (MONO)..... 63dB  
Stereo separation (1kHz) ..... 40dB

### AM tuner section

Frequency range (10kHz space)..... 530kHz~1700kHz  
Usable sensitivity (S/N=20dB)..... 31dB $\mu$  (36 $\mu$ V)

### CD player section

Laser diode.....GaAIAs  
Digital filter (D/A)..... 8 Times Over Sampling  
D/A Converter..... 24Bit  
Spindle speed .....500~200rpm (CLV)  
Wow & Flutter ..... Below Measurable Limit  
Frequency response ( $\pm$ 1dB) .....20Hz~20kHz  
Total harmonic distortion (1kHz)..... 0.01%  
Signal to Noise ratio (1kHz)..... 105dB  
Dynamic range .....93dB  
MP3 decode..... Compliant with MPEG-1/2 Audio Layer-3  
WMA decode..... Compliant with Windows Media Audio

### USB Interface

USB Standard ..... USB1.1/2.0 (Full speed)  
Maximum Supply current ..... 500mA  
File System ..... FAT16/32  
MP3 decode..... Compliant with MPEG-1/2 Audio Layer-3  
WMA decode..... Compliant with Windows Media Audio

### Audio section

Maximum output power ..... 50W x 4  
Full Bandwidth Power (at less than 1% THD) ..... 22W x 4  
Speaker Impedance .....4~8 $\Omega$   
Tone action  
    Bass ..... 100Hz $\pm$ 8dB  
    Middle ..... 1kHz $\pm$ 8dB  
    Treble ..... 10kHz $\pm$ 8dB  
Preout level / Load (CD) ..... 2000mV/10k $\Omega$   
Preout impedance .....  $\leq$ 600 $\Omega$

### Auxiliary input

Frequency response ( $\pm$ 3dB) .....20Hz~20kHz  
Input Maximum Voltage..... 1200mV  
Input Impedance ..... 10k $\Omega$

### General

Operating voltage (11~16V allowable)..... 14.4V  
Maximum Current consumption..... 10A  
Installation Size (W x H x D) ..... 182 x 53 x 155mm  
..... 7-3/16 x 2-1/16 x 6-1/8inch  
Weight ..... 2.9lbs (1.3kg)

# SPECIFICATIONS (KDC-U3046/U346/U4046)

## FM tuner section

Frequency range  
 200kHz space ..... 87.9 MHz~107.9MHz  
 50kHz space ..... 87.5MHz~108.0MHz  
 Usable sensitivity (S/N=26dB) ..... 11.2dBf (1 $\mu$ V/75 $\Omega$ )  
 Quieting Sensitivity (DIN S/N=46dB) ..... 19.2dBf (2.5 $\mu$ V/75 $\Omega$ )  
 Frequency response ( $\pm$ 3dB) ..... 30Hz~15kHz  
 Signal to Noise ratio (MONO) ..... 63dB  
 Stereo separation (1kHz) ..... 40dB

## AM tuner section

Frequency range  
 Band 1 (MW) ..... 530kHz~1700kHz (10kHz space)  
 ..... 531kHz~1611kHz (9kHz space)  
 Band 2 (SW1) ..... 2940kHz~7735kHz (5kHz space)  
 Band 3 (SW2) ..... 9500kHz~10135kHz/11580kHz  
 ~18135kHz (5kHz space)  
 Usable sensitivity (S/N=20dB)  
 MW ..... 31dB $\mu$  (36 $\mu$ V)  
 SW ..... 32dB $\mu$  (40 $\mu$ V)

## CD player section

Laser diode ..... GaAlAs  
 Digital filter (D/A) ..... 8 Times Over Sampling  
 D/A Converter ..... 24Bit  
 Spindle speed ..... 500~200rpm (CLV)  
 Wow & Flutter ..... Below Measurable Limit  
 Frequency response ( $\pm$ 1dB) ..... 20Hz~20kHz  
 Total harmonic distortion (1kHz) ..... 0.01%  
 Signal to Noise ratio (1kHz) ..... 105dB  
 Dynamic range ..... 93dB  
 MP3 decode ..... Compliant with MPEG-1/2 Audio Layer-3  
 WMA decode ..... Compliant with Windows Media Audio

## USB Interface

USB Standard ..... USB1.1/2.0 (Full speed)  
 Maximum Supply current ..... 500mA  
 File System ..... FAT16/32  
 MP3 decode ..... Compliant with MPEG-1/2 Audio Layer-3  
 WMA decode ..... Compliant with Windows Media Audio

## Audio section

Maximum output power ..... 50W x 4  
 Full Bandwidth Power (at less than 1% THD) ..... 22W x 4  
 Speaker Impedance ..... 4~8 $\Omega$   
 Tone action  
 Bass ..... 100Hz $\pm$ 8dB  
 Middle ..... 1kHz $\pm$ 8dB  
 Treble ..... 10kHz $\pm$ 8dB  
 Preout level / Load (CD) ..... 2000mV/10k $\Omega$   
 Preout impedance .....  $\leq$ 600 $\Omega$

## Auxiliary input

Frequency response ( $\pm$ 3dB) ..... 20Hz~20kHz  
 Input Maximum Voltage ..... 1200mV  
 Input Impedance ..... 10k $\Omega$

## General

Operating voltage (11~16V allowable) ..... 14.4V  
 Maximum Current consumption ..... 10A  
 Installation Size (W x H x D) ..... 182 x 53 x 155mm  
 Weight ..... 2.9lbs (1.3kg)

## SPECIFICATIONS (KDC-4047Ux/414Ux)

### FM tuner section

Frequency range (50kHz space)..... 87.5MHz~108.0MHz  
Usable sensitivity (S/N=26dB)..... 1 $\mu$ V/75 $\Omega$   
Quieting Sensitivity (DIN S/N=46dB)..... 2.5 $\mu$ V/75 $\Omega$   
Frequency response ( $\pm$ 3dB) .....30Hz~15kHz  
Signal to Noise ratio (MONO)..... 63dB  
Stereo separation (1kHz) ..... 40dB

### MW tuner section

Frequency range (9kHz space).....531kHz~1611kHz  
Usable sensitivity (S/N=20dB)..... 36 $\mu$ V

### LW tuner section

Frequency range ..... 153kHz~279kHz  
Usable sensitivity (S/N=20dB)..... 57 $\mu$ V

### CD player section

Laser diode.....GaAlAs  
Digital filter (D/A)..... 8 Times Over Sampling  
D/A Converter..... 24Bit  
Spindle speed .....500~200rpm (CLV)  
Wow & Flutter .....Below Measurable Limit  
Frequency response ( $\pm$ 1dB) .....20Hz~20kHz  
Total harmonic distortion (1kHz)..... 0.01%  
Signal to Noise ratio (1kHz)..... 105dB  
Dynamic range .....93dB  
MP3 decode..... Compliant with MPEG-1/2 Audio Layer-3  
WMA decode..... Compliant with Windows Media Audio  
AAC decode .....AAC-LC “.m4a” files

### USB Interface

USB Standard ..... USB1.1/2.0 (Full speed)  
Maximum Supply current ..... 500mA  
File System ..... FAT16/32  
MP3 decode..... Compliant with MPEG-1/2 Audio Layer-3  
WMA decode..... Compliant with Windows Media Audio  
AAC decode .....AAC-LC “.m4a” files

### Audio section

Maximum output power ..... 50W x 4  
Output power (DIN 45324, +B=14.4V) ..... 30W x 4  
Speaker Impedance .....4~8 $\Omega$   
Tone action  
    Bass ..... 100Hz $\pm$ 8dB  
    Middle .....1kHz $\pm$ 8dB  
    Treble .....10kHz $\pm$ 8dB  
\* Preout level / Load (CD)..... 2000mV/10k $\Omega$   
\* Preout impedance ..... $\leq$ 600 $\Omega$   
\* : Except KDC-4047UGY

### Auxiliary input

Frequency response ( $\pm$ 3dB) .....20Hz~20kHz  
Input Maximum Voltage..... 1200mV  
Input Impedance ..... 10k $\Omega$

### General

Operating voltage (11~16V allowable)..... 14.4V  
Maximum Current consumption..... 10A  
Installation Size (W x H x D) ..... 182 x 53 x 155mm  
Weight .....1.3kg

---

KENWOOD follows a policy of continuous advancements in development. For this reason specifications may be changed without notice.

---

**DANGER:**

Please do not look at the laser beam directly during repair or operation check.

